

Installation Guide

Sink Mixer- FWK03GN

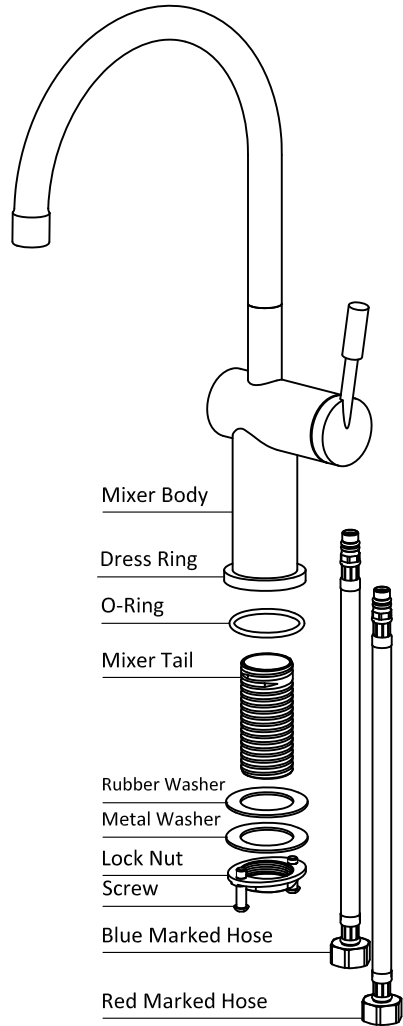

1 Cut a 35mm hole in diameter and ensure there are 60mm circle space for mounting.

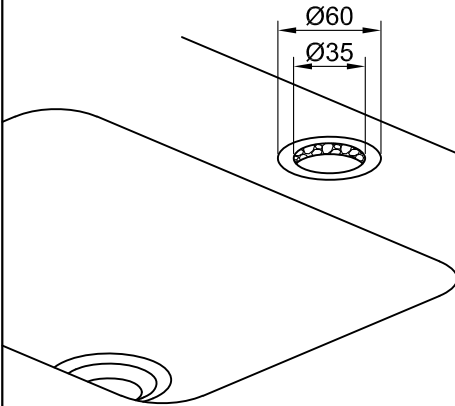

4 Underneath the mounting hole, firmly fasten the locknut and then tighten the screws.

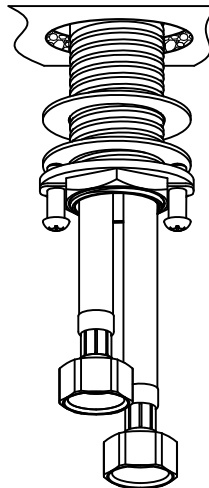

2 Underneath the Mounting hole, screw down the Lock nut till the end of Mixer tail, feed the Metal washer then Rubber washer from the upside onto the Mixer Tail.

Feed hoses through the mixer tail and then both mixer tail & hoses through the hole.

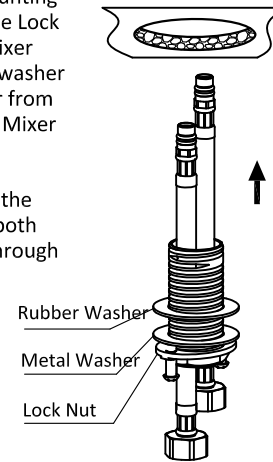

5 Connect hoses to the water supply.

Test and check for leaks.

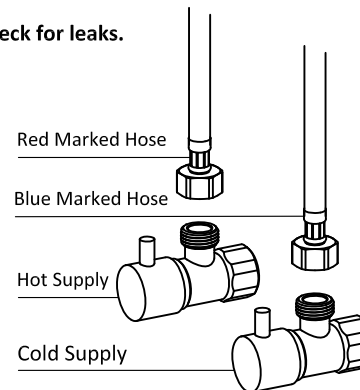

3 Position the O-ring in the dress ring groove and screw the hoses into the mixer body as shown.

Screw the mixer tail into the mixer body, place the mixer into position.

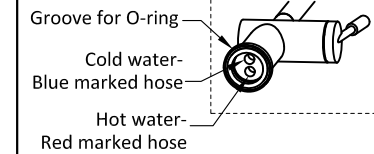

6 Finished Work

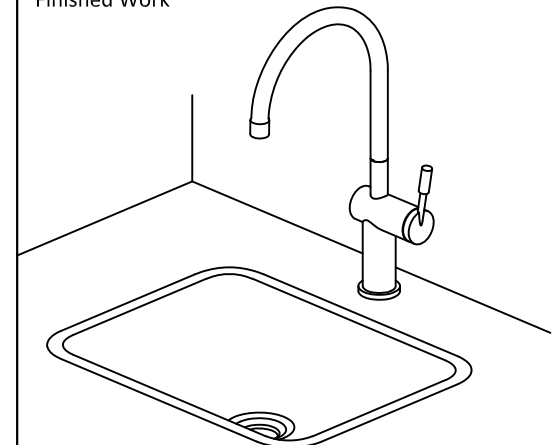

Notes

1. Pressure rating: 150-500kpa. If the pressure exceeds or is likely to exceed 550kpa, an approved pressure limiting device must be installed.
2. Temperature rating: 1-75°C. If the water temperature exceeds 55°C, an approved tempering valve must be fitted.
3. Flush out all pipes prior to installation.
4. Installation should comply with Australia standard AS/NZS3500 or relevant local authority requirements.

Maintenance and Care

1. All products should be cleaned with mild detergent or soapy water by using a soft cloth or dampened sponge.
2. Dry with a soft cloth after each use and clean regularly.
3. Do not use any chemical or abrasive cleaners.