

BVS327800

Caleffi 327 Series Ball/Check Valve 40f x 40f



### Technical Specification

- Body: brass EN 12165 CW617N, chrome plated
- Check valve spring: stainless steel
- Control Seal: EPDM
- Handle: aluminium
- Control Stem Seal: PTFE
- Medium: water, glycol solutions
- Max % of Glycol: 30%
- Max Pressure: 16 bar
- Min Pressure to open check: 0.02 bar
- Working temp: 5–110°C

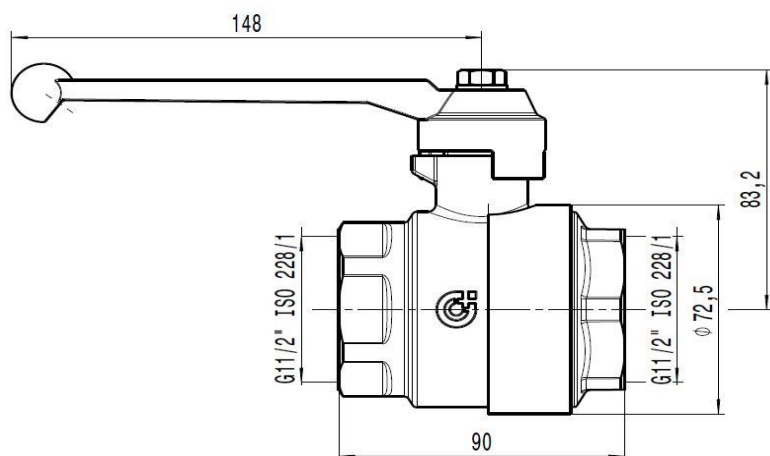

### Application

The Caleffi 327 Series Ball/Check Valve 40f x 40f is used in plumbing systems to control functionality of the system and is installed mostly in plant rooms.

### Warranty

[Download the latest warranty statement](#)

### Features

The ball valves with built-in check valve BALLSTOP combine two devices in a single body: a ball shut-off valve and a check valve housed inside the ball itself. This dual function allows for quicker installation and a more compact device, which means less space required on the pipe.