

EV556018

Caleffi 18L Expansion Tank Heating Only



Technical Specification

18L expansion vessel for central heating applications

Body: steel steel steel

Membrane: SBR

Type of membrane: diaphragm

Pipe connection: galvanised steel

Colour: red

Medium: water, glycol solutions

Max. percentage of glycol: 50%

Max. working pressure: 6 bar

Pre-charge pressure: 1,5 bar

System working temperature range: -10–120°C

Membrane working temperature range: -10–70°C

Construction: conforms to DIN 4807-2 and EN 13831

Application: heating

Pipe connection: 3/4" M (ISO 7-1)

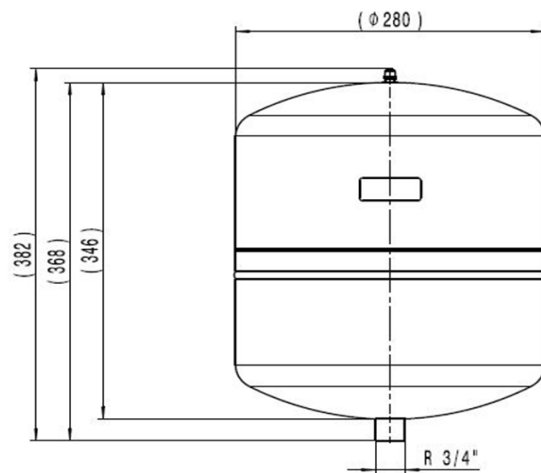
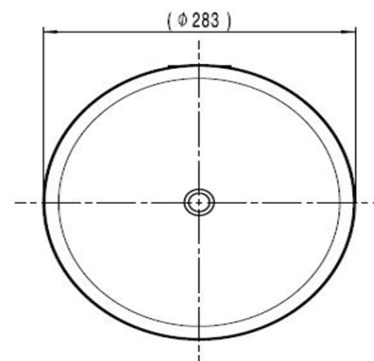

Application

The Caleffi 18L Expansion Tank Heating Only is used in heating systems to control functionality of the system and is installed mostly in plant rooms.

Warranty

[Download the latest warranty statement](#)

Features

Expansion vessels are devices designed to accommodate the increase in the volume of water due to the raising of its temperature, both in heating systems (556 series) and in domestic hot water production systems (568 series).

They are also used as hydro-pneumatic well in domestic water distribution systems. (568 series)