

Electric Round Towel Rail 240V



RTL600650CP

Electric Round Towel Rail 240V 600 x 650mm Chrome

Our extensive range of electric heated round towel rails come in satin black, chrome, brushed stainless, gun metal and brushed gold. They have left or right hand dual wiring, 240V and are AS/NZS 60335 safety approved. Made from stainless steel. Transformer not required for a 240V towel rail

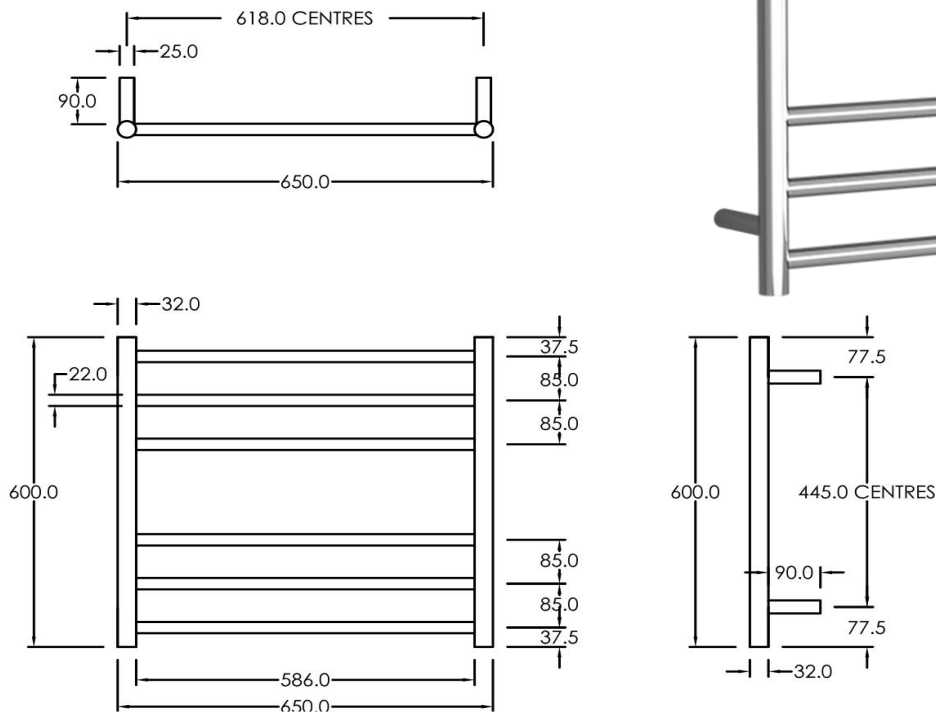

CARE AND USE

Bathroom Accessories

All finishes are smooth, abrasion resistant, corrosion resistant, fade-proof and easy to clean. All finishes are super hard wearing surfaces that won't chip, peel or tarnish with normal use. All surfaces should be regularly wiped clean with non scouring, neutral wash solutions.

LIMITED PRODUCT WARRANTIES

To be read in conjunction with and subject to all terms and conditions contained in the Waterware 'Producer Statement' available on-line (<http://www.waterware.co.nz/media-downloads>) From date of purchase, Waterware Services warrants products from the following categories to be free from manufacturing defect subject to exclusions (if applicable):

Category	Domestic Installations	Commercial Installations	Exclusions	Wels
Towel rails	5 years parts and labour	1 years parts and labour	None	Not required