

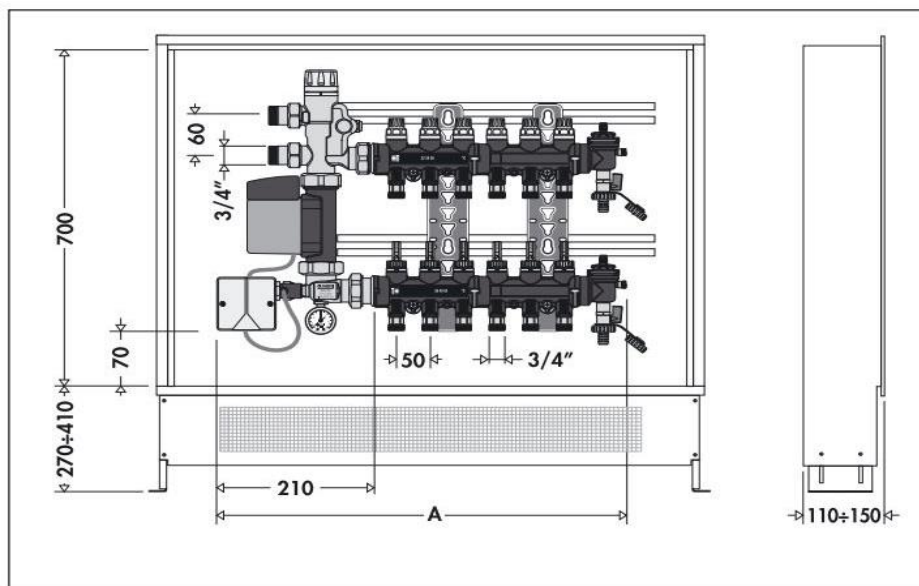

## Technical Specification

- Type: Mixing
- Maximum percentage of glycol: 30%
- Maximum inlet temperature (°C): 90
- Maximum working pressure (Bar): 4
- Pipe to manifold connectors: 16x2mm
- Panel circuit outlet coupler: 3/4" M
- Pipe outlet centres (mm): 50
- Primary circuit centres (mm): 60
- Case dimension: 700h x 1200w x 110d



Code	1825D1	1825F1	1825H1	1825L1	1825N1	1825N1
Panel outlets	4	6	8	10	12	14
A	485	585	685	785	885	985

## Warranty

[Download the latest warranty statement](#)

## Features

The Caleffi composite underfloor panels are fully assembled & wired, modules in cabinet ready to slot into the wall. The thermostatically regulated mixing panel is suitable for high temperature heat sources feeding a low temperature underfloor network. The manifolds ensure that the flow to each circuit is regulated precisely and also control the shut-off, venting and manual removal of air from the system.

Manifolds come fully equipped with flow meters, balancing valves, automatic air vent, fill/drain cock, manifold shut off valves and liquid crystal temperature indicators all as standard.