

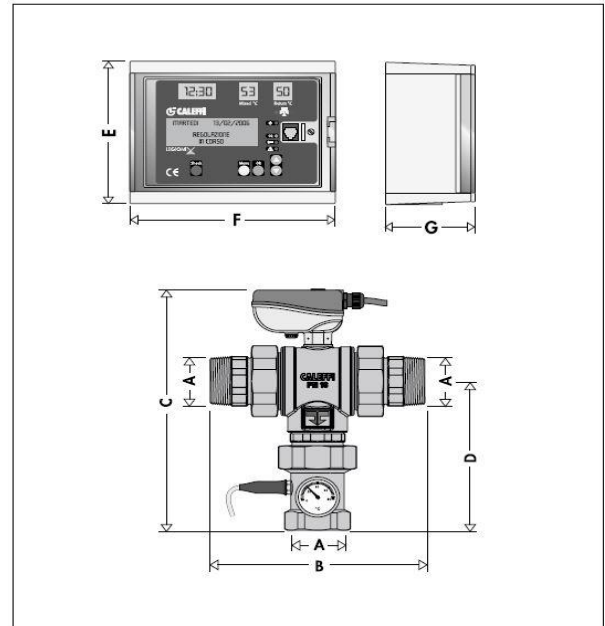

Technical Specification

- Valve body materials: brass EN 12165 CW617N
- Ball: brass EN 12165 CW614N, chrome plated, POM
- Maximum working pressure (static): 10bar
- Maximum inlet temperature: 100°C
- Actuator: Electric supply: 24V - 50/60 Hz directly from the regulator
- Power consumption: 6 VA
- Protection cover: self-extinguishing V0
- Protection class: IP 65
- Housing: self-extinguishing
- ABS Electric supply: 24V (ac) 50/60 Hz
- Power consumption: 6.5 VA
- Adjustment temperature range: 20–85°C
- Disinfection temperature range: 40–85°C
- Ambient temperature range: 0–50°C
- Protection class: IP 54 (Class II appliance)

Dimensions



Code	A	B	C	D	E	F	G	Mass (kg)
600054	3/4"	135	216	102,5	145	180	105	2,4
600064	1"	159	237	106,5	145	180	105	3,3
600074	1 1/4"	184	257	113,5	145	180	105	3,7
600084	1 1/2"	232	306	181	145	180	105	9,5
600094	2"	240	311	186	145	180	105	9,7

Application

The Caleffi 6000 50mm Legiomix is used in plumbing systems to control water temperature and is installed mostly in plant rooms.

Warranty

[Download the latest warranty statement](#)

Features

- Electronic 6000 thermostatic tempering valve with 50mm unions.
- For use on high demand centralised hot water systems with a flow rate between 33 and 805L/min ($\Delta p = 1.5\text{bar}$)
- Union connections with fibre washer seal (without check valves)
- Temperature range adjustable 20-80°C
- Temperature control +/- 2°C
- Thermostatic Disinfection Programming
- Transformer included
- Hourly flow and return temp data log for previous month
- 24V BMS integration and remote control via Modbus

