



Technical Specification

Threaded connections: UNI ISO 228/1 (Cylindric)

Working temperature: service limit from -20°C to +120°C

Maximum working pressure: 16PN

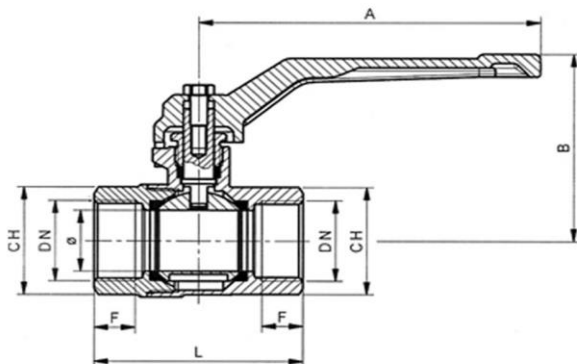

Cod.	0851/02	0851/03	0851/04	0851/05	0851/06	0851/07	0851/08	0851/09	0851/10	0851/11	0851/13
DN e pass. mm	1/4" (10)	3/8" (10)	1/2" (15)	3/4" (20)	1" (25)	1 1/4" (32)	1 1/2" (40)	2" (50)	2 1/2" (60)	3" (74)	4" (94)
L	41,5	41,5	50,5	61	71	83,5	93	112	138	161,5	181
B	44	44	46,5	61	64	79	85	106	123,5	136	167
F	8,5	8,5	10,5	12	13,5	15,5	15,5	19	26	27	28
CH	20	20	25	31	38	47	54	66	85	98	123
A	87	87	87	100	100	130	130	155	200	200	320

Application

The Airaga Ball Valve 50f x 50f is used in plumbing systems to control water flow rate or balancing and is installed mostly in plant rooms.

Warranty

[Download the latest warranty statement](#)

Features

Body and sleeve: hot moulded from EN12165 CW617N bar, nickel plated.

Gland and stem: worked from EN12164 CW617N bar.

Ball: 1/4" and 3/8" turned from EN12164 CW617N bar, from 1/2" to 2" hot moulded from EN12165 CW617N bar, from 2 1/2" to 4" melted in brass EN1982, diamond and chrome plated.

Antifriction ring: worked from EN12164 CW617N bar.

Ball gaskets: P.T.F.E.

Stem gasket: P.T.F.E.

Operating lever: die cast or melted in alluminium alloy UNI 1706, sandblasted and coated with epoxidic paints.

Screw: UNI 5739 - galvanized steel.

Seal for threads: "Loctite" type anaerobic adhesive.

External treatment : brilliant nickel plated surface