

Aspen PVD 700mm Single Kitchen Sink



AS74GM

Aspen PVD 700mm Single Kitchen Sink Gun Metal

Single kitchen sink insert in a gun metal finish

Waste and overflow included

700w x 400h x 210d (mm)

Note: Can be either installed via top mount or undermount installation

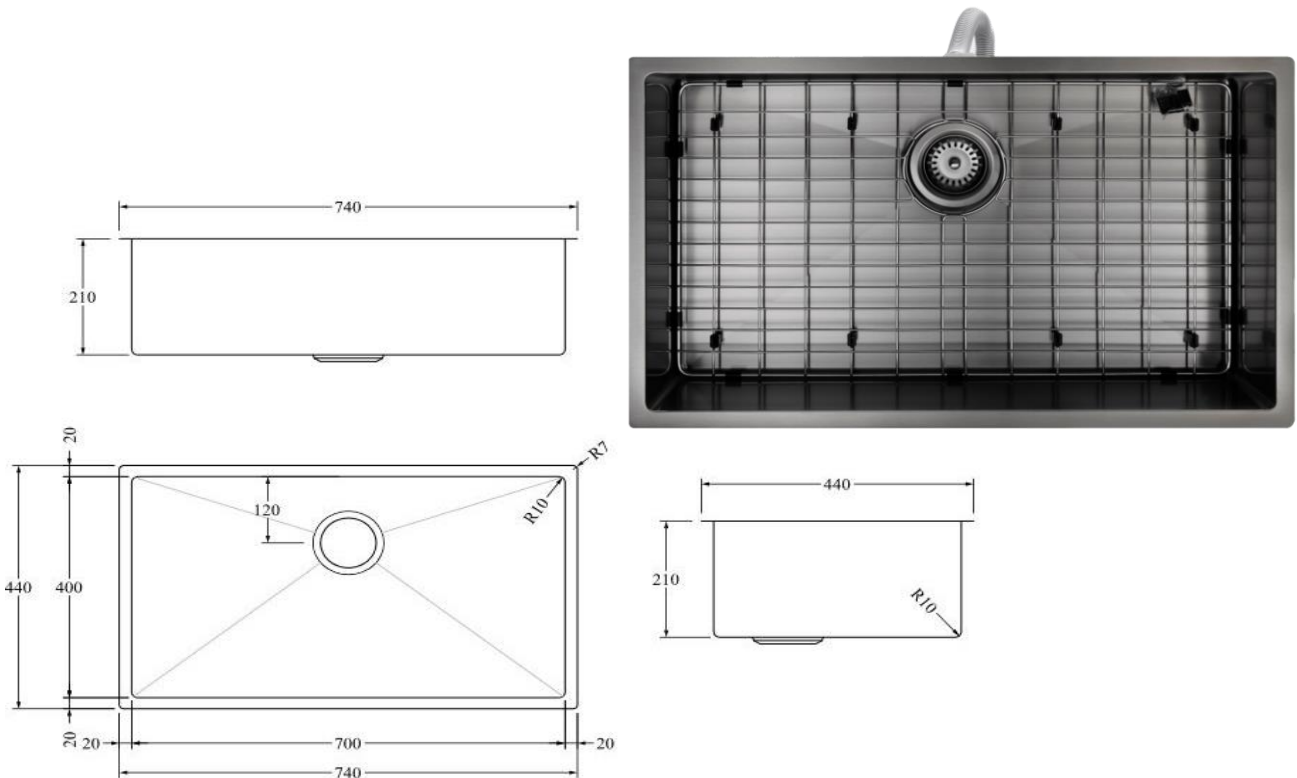

CARE AND USE

Aspen Sinks & Accessories

All finishes are smooth, abrasion resistant, corrosion resistant, fade-proof and easy to clean. All finishes are super hard wearing surfaces that won't chip, peel or tarnish with normal use. All surfaces should be regularly wiped clean with non scouring, neutral wash solutions.

LIMITED PRODUCT WARRANTIES

To be read in conjunction with and subject to all terms and conditions contained in the Waterware 'Producer Statement' available on-line (<http://www.waterware.co.nz/media-downloads>) From date of purchase, Waterware Services warrants products from the following categories to be free from manufacturing defect subject to exclusions (if applicable):

Category	Domestic Installations	Commercial Installations	Exclusions	Wels
Aspen Sinks	2 years parts/labour + 8 years parts only	1 year parts and labour + 1 year parts only	None	Not required