

RBSB350960

Fondital Blitz Super B4 Radiator 350mm x 960mm
1582W



fondital



Technical Specification

Dimensions: 350mm high x 960mm wide x 100mm deep
Output: @ 86/75/20: 1582watts
Max temp: 90°C
Max pressure: 16 bar
Colour: White RAL 9010

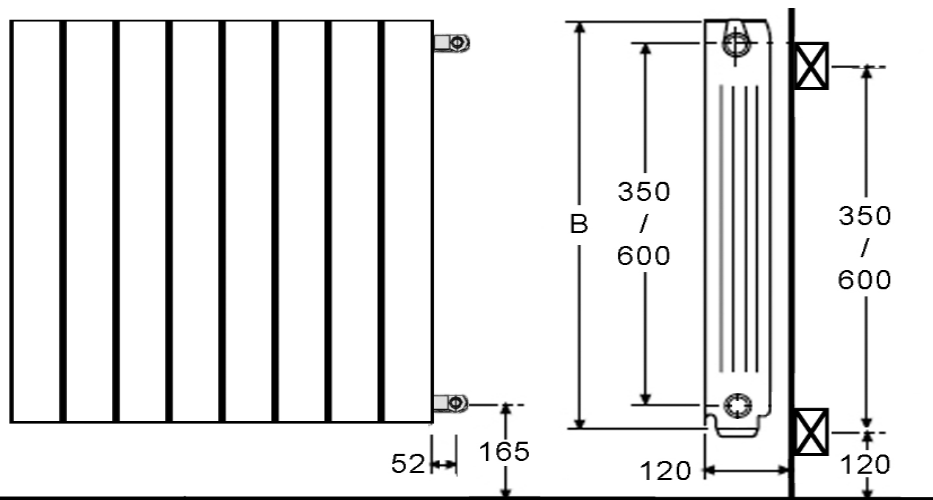

Application

The Fondital Blitz Super B4 Radiator 350mm x 960mm 1582W is used in heating systems to deliver radiant heating energy and is installed mostly at point of delivery.

Warranty

[Download the latest warranty statement](#)

Features

- Elegant, modern die-cast aluminium alloy radiator with high output performance.
- 4 x ports for either angle or straight radiator valves.
- Supplied with brackets, plugs and manual air vent.
- All surfaces treated with an anti corrosion treatment, primed then finished with RAL 9010 white epoxy polyester powder coat.
- Maximum working pressure 10bar, factory tested to 13bar.
- Shipped in carefully designed durable packaging.
- Produced according EN 442 standard.
- Made in Italy.