

RBSB600800

Fondital Blitz Super B4 Radiator 600mm x 800mm
1909W



fondital



Technical Specification

Dimensions: 600mm high x 800mm wide x 100mm deep
Output: @ 86/75/20: 1909watts
Max temp: 90°C
Max pressure: 16 bar
Colour: White RAL 9010

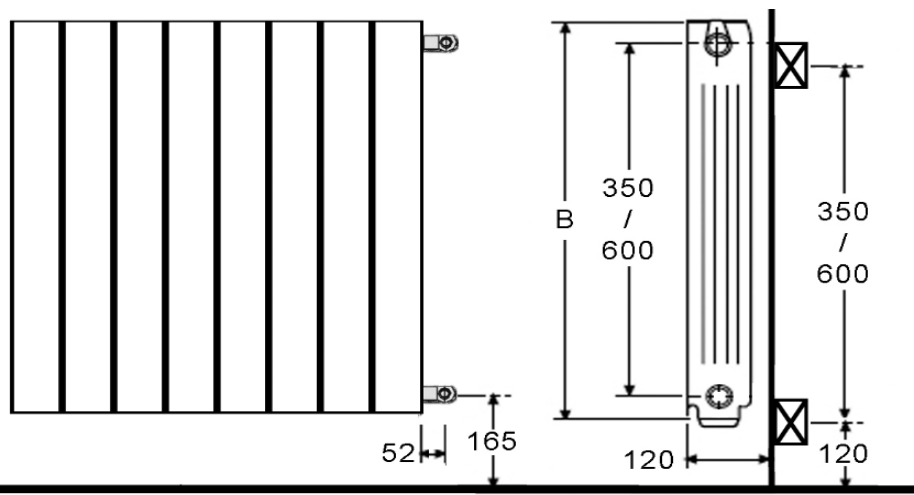

Application

The Fondital Blitz Super B4 Radiator 600mm x 800mm 1909W is used in heating systems to deliver radiant heating energy and is installed mostly at point of delivery.

Warranty

[Download the latest warranty statement](#)

Features

- Elegant, modern die-cast aluminium alloy radiator with high output performance.
- 4 x ports for either angle or straight radiator valves.
- Supplied with brackets, plugs and manual air vent.
- All surfaces treated with an anti corrosion treatment, primed then finished with RAL 9010 white epoxy polyester powder coat.
- Maximum working pressure 10bar, factory tested to 13bar.
- Shipped in carefully designed durable packaging.
- Produced according EN 442 standard.
- Made in Italy.