

RSB21400600

Brugman Type 21 400mm x 600mm 726W



Technical Specification

Material: Steel
 Finishing: Top grille and side panels
 Valve: The valve insert (without thermostatic valve) is compatible with thermostatic valves M30 x 1,5
 J-bracket set: blind plug, air vent, plugs
 VDI-compliant in conformity with VDI 6036 (class III)
 Connections: 2 x 3/4" external thread euroconus right bottom connection, 4 x 1/2" internal thread side connections.
 The UNI6 horizontal model has a bottom connection and four side connections. By using the J-bracket it is possible to mirror reverse the radiator, so that the thermostat knob can be mounted on the left or right.
 Packaging: Each radiator is robustly packaged in high-quality cardboard and then shrink-wrapped.
 Painting process: All radiators are degreased, phosphated, cathodically primed and powder-coated
 Colour: RAL 9016
 Maximum operating pressure: 10 bar (tested at 13 bar)
 Maximum operating temperature: 120 °C
 Conformity: In accordance with EN442-1: 2014: radiators and convectors

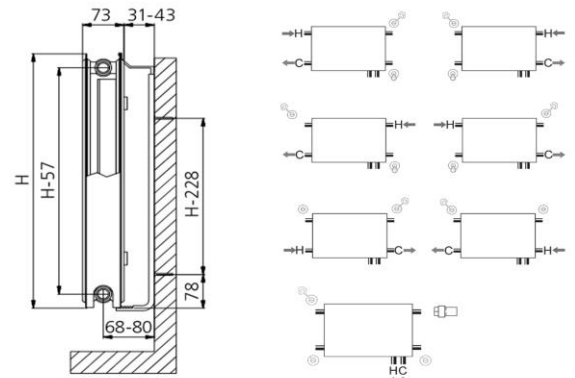

Application

The Brugman Type 21 400mm x 600mm 726W is used in heating systems to deliver radiant heating energy and is installed mostly at point of delivery.

Warranty

[Download the latest warranty statement](#)

Features

- Strong and durable, steel panel radiators are a good choice for a family home or commercial space.
- 400mm high x 600mm wide x 82mm deep
- 726 watts calculated with 85°C flow, 75°C return
- Multi-port options for side or bottom entry valves
- Presented in a top coat of RAL 9016 epoxy-powder paint
- Maximum operating pressure 10bar, maximum operating temperature 120°C
- Well packaged with thick cardboard top and bottom caps then shrink wrapped in a tough polythene film
- Supplied with wall mounting J brackets, air vent and port plugs