

RSB21600120

Brugman Type 21 600mm x 1200mm 2014W



Technical Specification

- Material: Steel
- Finishing: Top grille and side panels
- Valve: The valve insert (without thermostatic valve) is compatible with thermostatic valves M30 x 1,5
- J-bracket set: blind plug, air vent, plugs
- VDI-compliant in conformity with VDI 6036 (class III)
- Connections: 2 x 3/4" external thread euroconus right bottom connection, 4 x 1/2" internal thread side connections
- Packaging: Each radiator is robustly packaged in high-quality cardboard and then shrink-wrapped.
- Painting process: All radiators are degreased, phosphated, cathodically primed and powder-coated
- Colour: RAL 9016
- Maximum operating pressure: 10 bar (tested at 13 bar)
- Maximum operating temperature: 120 °C
- Conformity: In accordance with EN442-1: 2014: radiators and convectors

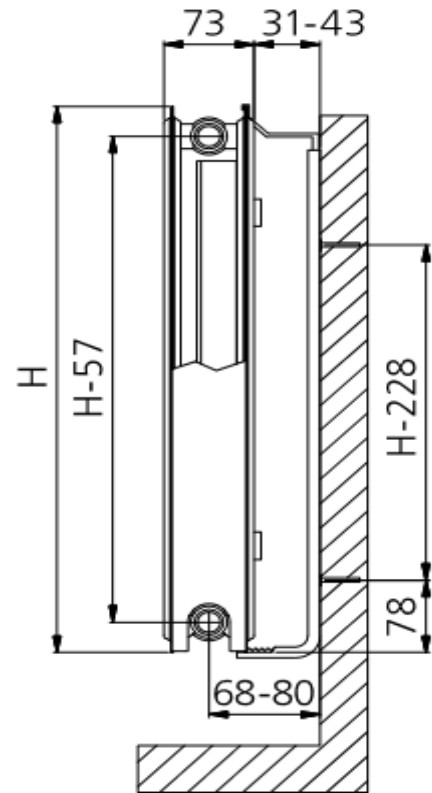
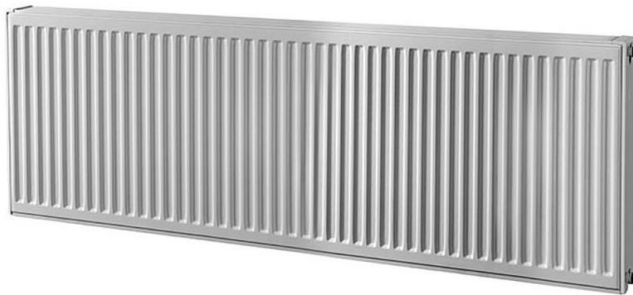

Application

The Brugman Type 21 600mm x 1200mm 2014W is used in heating systems to deliver radiant heating energy and is installed mostly at point of delivery.

Warranty

[Download the latest warranty statement](#)

Features

- Strong and durable, steel panel radiators are a good choice for a family home or commercial space.
- 600mm high x 1200mm wide x 82mm deep
- 2014 watts calculated with 85°C flow, 75°C return
- Multi-port options for side or bottom entry valves
- Presented in a top coat of RAL 9016 epoxy-powder paint
- Maximum operating pressure 10bar, maximum operating temperature 120°C
- Well packaged with thick cardboard top and bottom caps then shrink wrapped in a tough polythene film
- Supplied with wall mounting J brackets, air vent and port plugs