

RSB21600400

Brugman Type 21 600mm x 400mm 671W



Technical Specification

Material: Steel

Finishing: Top grille and side panels

Valve: The valve insert (without thermostatic valve) is compatible with thermostatic valves M30 x 1,5

J-bracket set: blind plug, air vent, plugs

VDI-compliant in conformity with VDI 6036 (class III)

Connections: 2 x 3/4" external thread euroconus right bottom connection, 4 x 1/2" internal thread side connections

Packaging: Each radiator is robustly packaged in high-quality cardboard and then shrink-wrapped.

Painting process: All radiators are degreased, phosphated, cathodically primed and powder-coated

Colour: RAL 9016

Maximum operating pressure: 10 bar (tested at 13 bar)

Maximum operating temperature: 120 °C

Conformity: In accordance with EN442-1: 2014: radiators and convectors

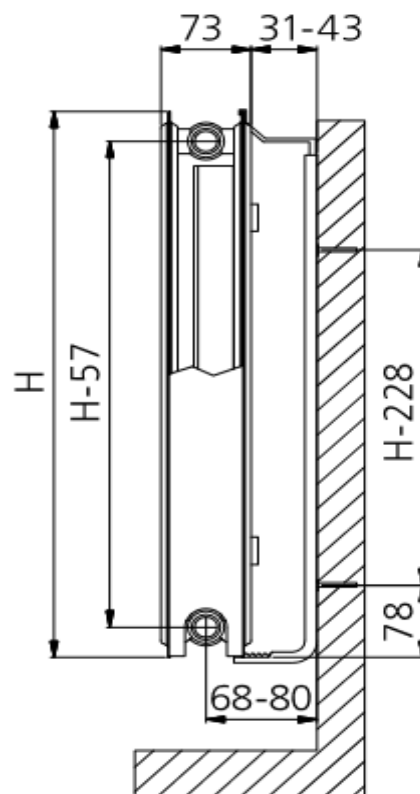

Application

The Brugman Type 21 600mm x 400mm 671W is used in heating systems to deliver radiant heating energy and is installed mostly at point of delivery.

Warranty

[Download the latest warranty statement](#)

Features

Strong and durable, steel panel radiators are a good choice for a family home or commercial space.

600mm high x 400mm wide x 82mm deep

671 watts calculated with 85°C flow, 75°C return

Multi-port options for side or bottom entry valves

Presented in a top coat of RAL 9016 epoxy-powder paint

Maximum operating pressure 10bar, maximum operating temperature 120°C

Well packaged with thick cardboard top and bottom caps then shrink wrapped in a tough polythene film

Supplied with wall mounting J brackets, air vent and port plugs