

DSV253048

Caleffi 253 Series Solar Safety Valve 15mm x 20mm
800kPa



Technical Specification

Materials:

Body: brass EN 12165 CW 617N, chrome plated

Control Spindle: brass EN 12164 CW614N

Obturator Seal: high resistance elastomer

Spring: stainless UNI 3823

Control Knob: PA6G30

Medium: water, glycol solutions

Max % of Glycol: 50%

Nominal Pressure: PN 10

Temperature Range: -30–160°C

Opening Overpressure : 10%

Closing Differential: 20%

Discharge Capacity: 50kW



Application

The Caleffi 253 Series Solar Safety Valve 15mm x 20mm 800kPa is used in plumbing systems to provide a safety function and is installed mostly in plant rooms.

Warranty

[Download the latest warranty statement](#)

Features

Safety relief valve for solar thermal systems

15mm inlet x 20mm outlet, 800kPa

Female connections

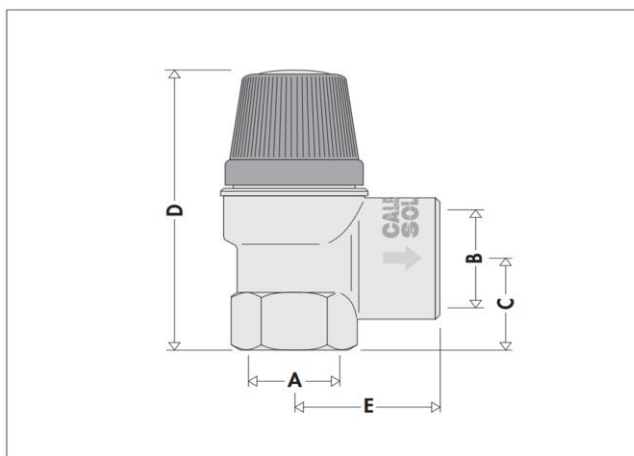

Code	A	B	C	D	E	Weight (kg)
25304.	1/2"	3/4"	24	70	33,5	0,22