

DSV527730

Caleffi 527 Series Safety Valve 32mm x 40mm  
300kPa



## Technical Specification

Body: brass EN 1982 CB753S  
Cover: brass EN 12165 CW617N  
Control Stem: brass EN 12164 CW614N  
Obturator Seal: EPDM  
Diaphragm: EPDM  
Spring: steel EN 12270-1  
Control Knob: PA6G20  
Nominal Pressure: PN10  
Working Temperature Range: 5-110°C

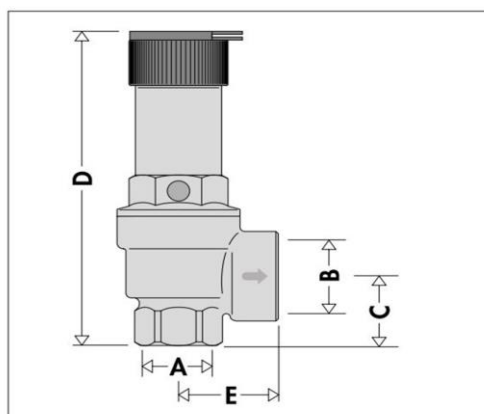

Code	A	B	C	D	E
5274.. EST	1/2"	3/4"	26	93	33
5275.. EST	3/4"	1"	30	136	39,5
5276.. EST	1"	1 1/4"	39	166	48
5277.. EST	1 1/4"	1 1/2"	42,5	185	56



## Application

The Caleffi 527 Series Safety Valve 32mm x 40mm 300kPa is used in plumbing systems to provide a safety function and is installed mostly in plant rooms.

## Warranty

[Download the latest warranty statement](#)

## Features

The standard safety relief valves 527 series are used in heating systems, in domestic water systems to protect the hot water storage and in hydraulic systems.

527 EST series valves are fail-safe devices, i.e. they are guaranteed to operate even in the case of wear or breakage of the diaphragm.

32mm x 40mm outlet, 300kPa

Female connections