

CPR15

Caleffi 5335 H Series Pressure Reducing Valve
15mm



Technical Specification

Body: DZR Brass EN 12165 CW602N
Control Spindle: Stainless steel EN 10088-3
Cartridge: PPS-PSU
Internal components: DZR EN 12165 CW724R
Diaphragm: EPDM
Seals: EPDM
Strainer: stainless steel EN10088-2 (AISI 304)



Max. upstream pressure: 2000kPa
Downstream pressure setting range: 100kPa - 600kPa
Factory setting: 500kPa
Max. working temperature: 80°C
Medium: water
Connections:
Main connections: 1/2" F
Pressure gauge connection: 1/4" F (ISO 228-1)
Approvals: Certified to AS 1357.2

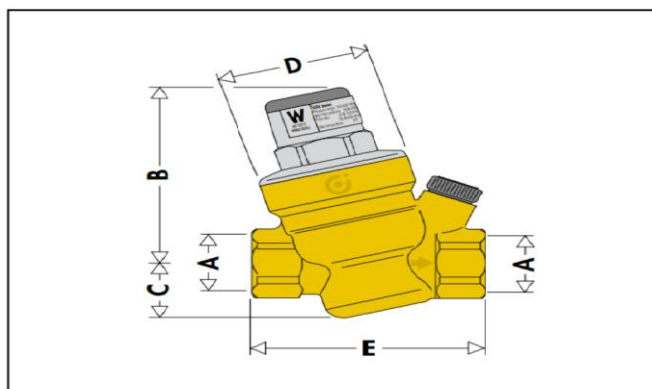

Code	DN	A	B	C	D	E	Mass (kg)
533545H AUS	15	1/2"	74,5	22	Ø 46	79	0,45
533555H AUS	20	3/4"	74,5	22	Ø 46	84,5	0,46
533565H AUS	25	1"	74,5	23	Ø 46	95	0,54

Application

The Caleffi 5335 H Series Pressure Reducing Valve 15mm is used in plumbing systems to control water pressure and is installed mostly in hot water cylinder cupboards.

Warranty

[Download the latest warranty statement](#)

Features

Pressure reducing valves are installed in residential water system to reduce and stabilise inlet pressure from the water network which is generally too high and variable for domestic systems to work properly. The 5335 H series can also be used to control inlet pressure to domestic hot water storage and in hot water applications