

CTPR20-7

Caleffi TPR Valve 20mm 700kPa



Technical Specification

Materials:

- body: dezincification resistant alloy EN 12165 CW602N
- stem: brass EN 12164 CW614N
- obturator and diaphragm: EPDM
- spring: steel EN 10270-1 SH
- control knob: PA6G30

Nominal pressure: PN10

Discharge rating: 25kW

Medium: Water

PED Category: IV

Settings:

- temperature: 90°C
- pressure: 700kPa

Connections: 3/4" M x Ø 20 mm with compression fitting for copper pipe

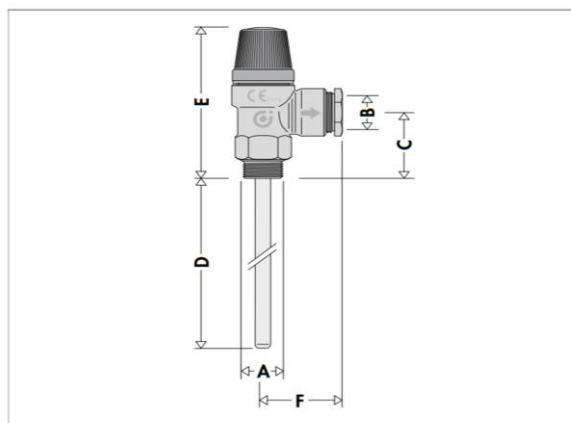

Code	A	B	C	D	E	F	Weight (kg)
3095.0	3/4"	Ø 22	43	99	91	39	0,310



Application

The Caleffi TPR Valve 20mm 700kPa is used in plumbing systems to control water pressure and is installed mostly in hot water cylinder cupboards.

Warranty

[Download the latest warranty statement](#)

Features

The TP relief valve controls and limits the temperature and pressure of the hot water contained in a domestic storage heater and prevents it from being able to reach temperatures of over 100°C, with the formation of steam.

On reaching the settings, the valve discharges a sufficient amount of water into the atmosphere so that the temperature and pressure return within the system's operating limits.