

PR535080H

Caleffi 535 Series High Temp Low Lead Pressure Reducing Valve 40mm



Technical Specification

- Body: Dezincification resistant alloy brass EN1982 CC768S
- Control Stem: Dezincification resistant alloy EN12164 CW724R
- Strainer: Stainless steel
- Moving parts: Dezincification resistant alloy EN12164 CW724R
- Diaphragm, Seals: EDPM
- Max. upstream pressure: 25 bar
- Downstream pressure setting range: 1–6 bar
- Factory setting: 3 bar
- Max. working temperature: 80°C
- Strainer mesh size: 0.65 mm

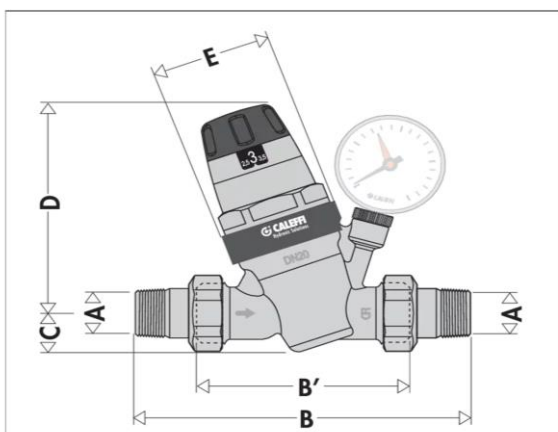

Code	DN	A	B	B'	C	D	E	Mass (kg)
53508.H	40	1 1/2"	220	120	40	178	Ø78	3,3



Application

The Caleffi 535 Series High Temp Low Lead Pressure Reducing Valve 40mm is used in plumbing systems to control water pressure and is installed mostly in plant rooms.

Warranty

[Download the latest warranty statement](#)

Features

- High temp, low lead 535 series pressure reducing valve with 40mm unions
- For use on hot water systems with a flow rate up to 152L/min @2m/s
- Union connections with fibre washer seal