

messana



sense



We created **mSense** for your Comfort and Energy Saving

to deliver the best Thermal Wellbeing™ in your home



designed in California & made in Italy

mSense: a new generation of room comfort sensors

In the past, typical room thermostats only provided air temperature as the sole index of thermal conditions in your home. An HVAC control system based uniquely on air temperature does not account for other key comfort elements, such as **mean radiant temperature, air temperature and velocity, humidity and air quality.**

This is why at Messana we have invented mSense, a new generation of room sensors to enhance comfort and energy efficiency.

mSense measures the three fundamental indoor environmental parameters that influence the wellbeing and thermal conditions of occupants: operative temperature, relative humidity (dew-point) and air quality.

Operative Temperature.

mSense measures the operative temperature by combining the influence of air and mean radiant temperature in a similar way as the skin's thermal receptors of human body do.

Integrating in a control system a sensor that is also influenced by the thermal radiation provides more accurate results than air temperature alone.

Relative Humidity (dew-point).

Measuring and controlling humidity levels in buildings is very important for both comfort and health. It is also crucial in properly controlling radiant cooling systems.

mSense is equipped with a stable and accurate sensor to measure humidity and dry bulb temperature. Based on these measurements it precisely evaluated the dew-point temperature.

Air Quality.

As an offered option, mSense can be equipped with a sophisticated gas sensor that goes beyond the carbon dioxide (CO₂) by analyzing substances that directly affect your health and help improve the indoor air quality and save energy.

The Indoor Air Quality IAQ sensor monitors the equivalent CO₂ and the Total Volatile Organic Compounds (TVOCs).

Smart radiant cooling and heating in your home

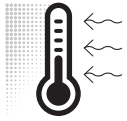

Operative Temperature

Operative temperature is the combined effects of the mean radiant temperature and air temperature. When it comes to thermal comfort, the operative temperature express what humans thermally experience in a space. It is a sort of measure of the body's response to the convective and radiant energy exchange.



Dew-point temperature

The dew-point temperature is an important measurement of the content of moisture in the air. An accurate reading is fundamental to properly control hydronic radiant cooling systems. It dictates the water supply temperature preventing any potential condensation on the radiant surface.



Air Quality

Volatile Organic Compounds are toxic chemicals that can be dangerous even at low concentrations and can have health effects. Most notably, Formaldehyde has been proven as carcinogenic. mSense measures the Total VOCs level and allows the control system to activate the air renewal process.

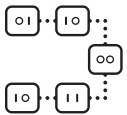

Serial Connection

mSense is based on a standard two-wire RS485 serial connection and is compatible with Modbus and BACnet communication protocols. The physical strength of the RS485 provides robust and reliable connectivity in the most challenging environments.

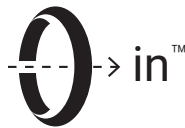

O-in™ Mount Technology

mSense O-in™ mounting technology, allows quick and easy installation by simply pushing the sensor into the wall adapter. The securing of the sensor is simply achieved by friction between the rubber o-ring and the metal O-in™ drywall adapter sleeve.



Paintable Surface

mSense is available in a white matte high quality plastic polymer that can be painted to match your wall color. Architects and designers have freedom to develop their vision without having to incorporate large, unsightly thermostats that detract from the beauty of a space



Operative temperature: more than just air temperature

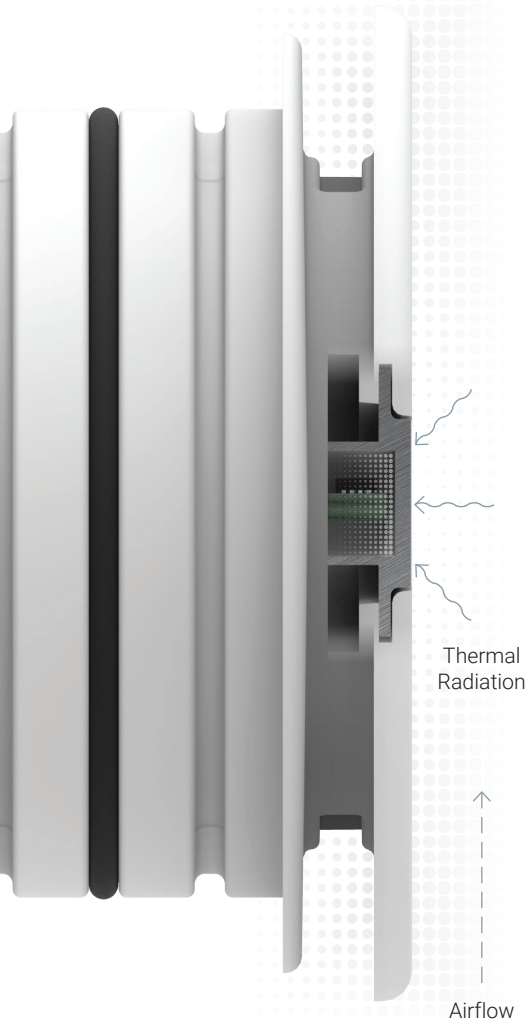

The room temperature sensor is the first element of a heating and cooling control system. It is a fundamental element to achieve the quality of control, and ultimately the comfort experienced in the building.

When evaluating the thermal comfort of a space, it is important not to focus solely on dry-bulb air temperature. There are other key factors to consider: the mean radiant temperature (MRT), the air temperature and velocity, and the humidity.

To achieve the best thermal comfort results, it is necessary to control the room temperature as a function of the operative temperature.

The operative temperature accounts for the effects of both air and mean radiant temperatures. While air temperature is commonly used, mSense accounts also for the thermal radiation in a room.

The mSense embedded operative temperature sensor is influenced by radiant and convective heat exchange, in a similar way as a person. In fact, the human body has temperature receptors within the skin that sense both thermal radiation and airflow. mSense is equipped with a metal half-sphere (or a flat capsule, depending on the model) ^{note 1} that works in a similar way as a globe thermometer.

Note 1

mSense is available with two different radiant temperature globe terminals: flat and dome. The flat terminal is the preferred by architects since it presents less interference with the beauty of the space. The dome option, because of his rounded shape, provides higher sensitivity to the radiant heat from the environment.



Flat



Dome

Typical room thermostats only provide dry-bulb air temperature as the sole index of the thermal conditions of the space. Unfortunately, the focus on air temperature has led to poor indoor climate solutions limited to blowing hot and cold air instead of focusing on the mean radiant temperature.

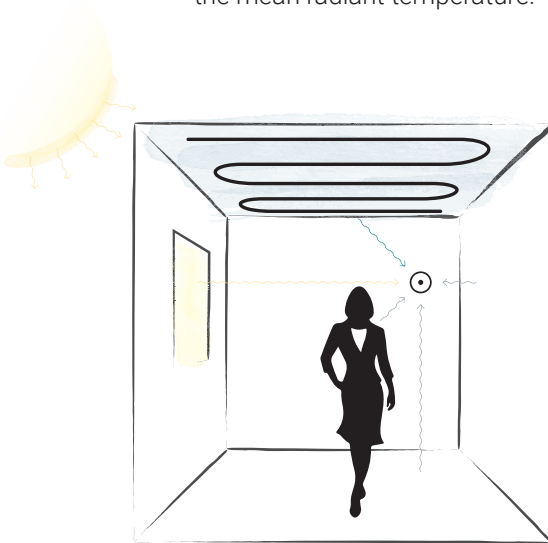

$$T_{\text{operative}} \approx \frac{(T_{\text{air}} + T_{\text{surface}})}{2}$$

Operative temperature is what humans perceive thermally in a space. Basically, it is a simplified measure of the **Thermal Wellbeing™**.

People typically respond to thermal discomfort by continuously readjusting their thermostat. The problem is that an air based thermostat never represents the real human thermal exchange. mSense comfort sensor is an essential element of a climate control system especially in presence of radiant ceiling panels but also in conventional radiant floor and air systems.

Integrate mSense in your control system to deliver more accurate results and to achieve optimal comfort performance.

Humidity: an essential element for your comfort and health

What is the difference between dew-point and relative humidity?

Meteorologists rarely talk about relative humidity (RH). Instead, they tend to use the term “dew-point” temperatures.

Why? Both are measures of the water content of the air:

- Dew-point is the temperature at which the air can no longer hold moisture, and condensate in dew.
- Relative humidity is the amount of moisture in the air at a certain temperature.

If the dew-point is 60°F, and the air temperature drops below 60°F, you will see fog or dew. If you get a bottle out of the fridge with a surface temperature of 55°F and if the dew-point of the air is below 55°F, drops of condensation will form on the bottle.

Humidity hinges on the word “relative”; it is relative to the temperature. When a relative humidity is given, it should also be related to the air temperature. For example: “RH 50% at 72°F”.

Examples:





- Let’s assume a constant dew-point of 70°F, on a summer day when the air temperature is 90°F. In this case, the relative humidity is “just” at 52%. That seems almost comfortable, but if you walked out there you might be sweating.
- On the other hand, in the winter you could have a 45°F day with a dew-point of 40°F, and in this case the relative humidity would be “very high” at 81%. However if you stepped outside it wouldn’t feel so humid! It’s feels just cold.

Under the same condition of moisture content, for example a dew-point temperature at 55°F (optimal comfort condition), you could have different relative humidity, depending on the air temperature.

Temperature	Relative humidity under a given dew-point temperature of 55°F
80°F	42%
75°F	50%
70°F	60%
55°F	100% (when dew-point and temperature are the same, RH is 100%)

This is why the dew-point is a more representative expression of water content and meteorologists prefer the consistent message that comes with it.

Optimal moisture conditions

Dew-point	How would you feel?
<50°F	 too dry
50-60°F	 optimal condition, most of the people feel comfortable
61-70°F	 uncomfortable
>70°F	 very uncomfortable, too muggy

Why is the dew-point so important in a hydronic radiant cooling system?

In a radiant cooling system, each conditioned room of a building requires an accurate reading of the dew-point ($\pm 2^\circ\text{F}$). Based on the dew-point temperature, the radiant cooling control system adjusts the water supply temperature in order to prevent the ceiling surface temperature to go below the room dew-point temperature and avoid condensation.

The same apply for radiant floors.

The effect of humidity on human body.

Research indicates that for health and comfort, a relative indoor humidity of 40% to 60% (with temperature in the 70s) is desirable. This means a dew-point temperature between 50°F and 60°F.

In general humidity is directly related to the amount of allergens in the indoor environment, and should be controlled. Humidity also effects the thermal comfort: the higher humidity, the higher the temperature actually feels. Also, low humidity can have negative effects on the human body: excessive body loss of water can affect the skin and the respiratory system.

mSense is a fundamental element of a radiant cooling system to keep always the moisture under control.



Smart Indoor Air Quality for better health and energy efficiency

People spend 90% of their time indoors where concentrations of pollutants are significantly higher than outdoors. The widespread use of new building materials and improved insulation technology, has resulted in increased concentrations of volatile organic compounds (VOCs). These VOCs originate mainly from paints and solvents, carpets and furniture, and can also be emitted by humans. Elevated VOC levels can have a negative impact on well being and comfort.

Messana mSense integrates an innovative air quality sensor that constantly monitor the Total VOC and the equivalent CO₂. This allows to increase the efficiency of the ventilation and air purification to improve the indoor air quality and the Thermal Wellbeing™ experience.

What is in the air that we breathe?

Clean air simply comprises of 21% oxygen and 79% nitrogen. However, in real life and in particular indoors, this looks rather different. Various additional components, such as noble gases, carbon monoxide (CO), carbon dioxide (CO₂), and volatile organic compounds (VOCs) are found in the air that we breathe. In particular, the latter two are the most important one. CO₂, due to its HVAC industry awareness level and VOCs, due to their criticality.

The role and impact of VOCs in indoor air

About 5,000 to 10,000 different VOCs exist. They are two to five times more likely to be found indoors than outdoors. Indoor VOCs are various types of hydrocarbons from mainly two sources: bio-effluents, i.e. odors from human respiration, transpiration, and metabolism and building material as well as furniture. VOCs are known to cause eye irritations, headache, drowsiness or, even dizziness, all summarized under the term SBS (sick building syndrome). VOCs are the one and only root cause for the need to ventilate! Some typical indoor contaminants and their sources are shown in the table below in which VOCs caused by humans have the lion's share over building material, furniture and office equipment, hence rule the demand for ventilation.

Typical indoor air contaminants

Indoor Air		Typical Substance		Cure
Contamination Source	Emission Source	VOCs	Others	
Human Being	Breath	Acetone, Ethanol, Isoprene		mecchancal ventilation
		CO ₂		
		Humidity		
	Skin respiration and transpiration	Nonanal, Decanal, α-Pinene		
		Humidity		
	Flatus	Methane, Hydrogen		
	Cosmetics	Limonene, Eucalyptol		
Household Supplies	Alcohol Esters, Limonene			
Combustion (Engines, Appliances, Tobacco Smoke)	CO			
	CO ₂			
	Humidity			
Building Material, Furniture, Office Equipment, Consumer Products	Paints, Adhesives, Solvents, Carpets	Formaldehyde, Alcanes, Alcohols, Carbonyls, Ketones, Sloxanes		permanent ventilation (5-10%)
	PVC	Toulene, Xylene, Decane		
	Printers/Copiers, Computers	Benzene, Styrene, Phenole		

Intelligent air quality sensor that goes beyond CO₂

Although CO₂ plays a major role in modern ventilation control systems, sole CO₂ has not a real impairment on humans. As decades of submarine experience and ISS (International Space Station) experiments confirm: even heavy CO₂ concentrations of 1% (10,000 ppm) show no impact on our wellbeing. Nonetheless, due to the lack of suitable VOC sensing devices, historically CO₂ values have served as adequate air quality indicator, reflecting the total amount of VOCs (TVOCs) since the amount of CO₂ is proportional to the amount of VOCs, produced by human respiration and transpiration. At least in average, as shown in the graph below.

Therefore the ease of reduction to one single parameter, compared to consideration of some 1,000s VOCs, and the availability of suitable CO₂ measuring technology made it the surrogate of inhabitant generated pollution in confined living spaces i.e. today's standard indoor air quality reference for DCV with tangible air quality definitions (right table) as initially introduced by Maxvon Pettenkofer and picked up by most HVAC industry standards.

CO ₂ [ppm]	Air Quality
2100	bad heavily contaminated indoor air ventilation required
2000	
1900	
1800	
1700	
1600	
1500	mediocre contaminated indoor air ventilation recommended
1400	
1300	
1200	
1100	fair
1000	
900	good
800	
700	excellent
600	
500	
400	

CO₂ and VOCs from business meeting session

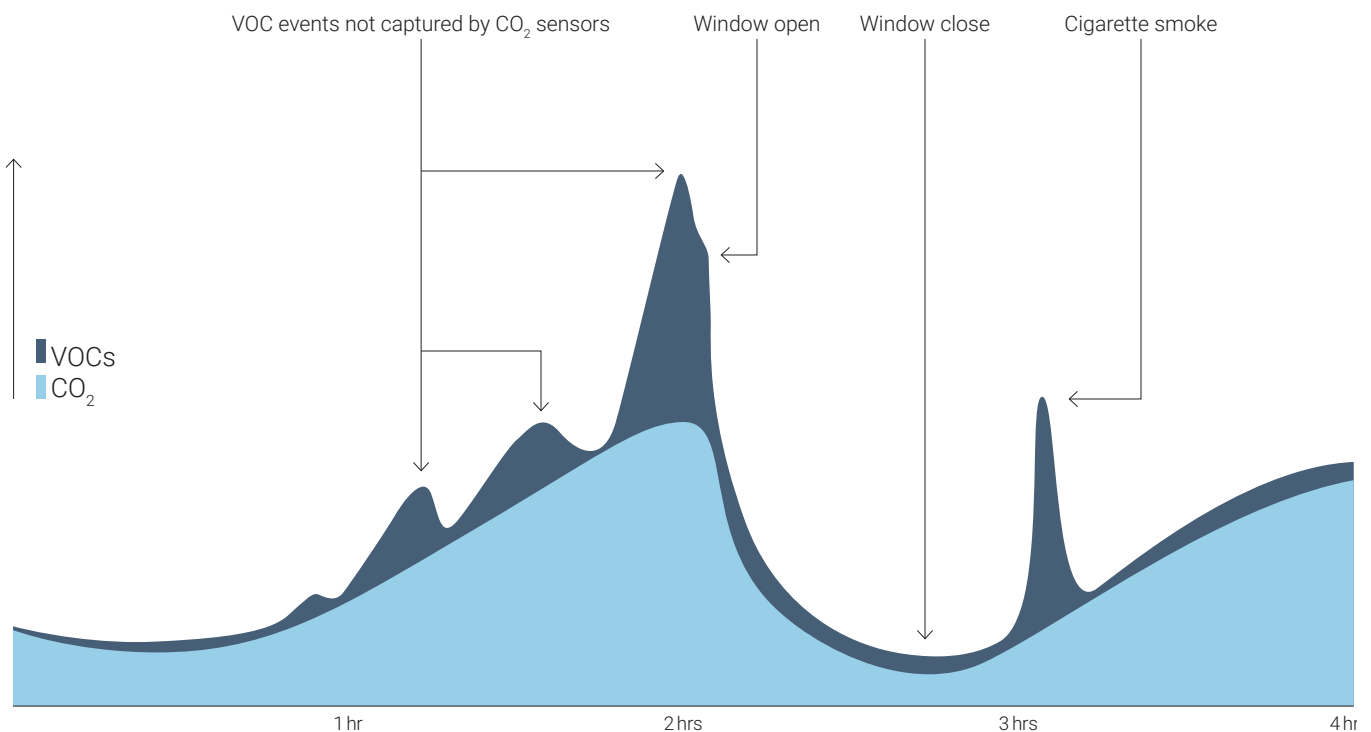

Technical specifications

Sensors

Operative Temperature	
Sensor	Sensirion STS30
Typical accuracy	±0.166°F (±0.3°C)
Operative temperature range <small>note 3</small>	-40 to +257°F (-40 to +125°C)

Dry Bulb Air Temperature (DB) and Relative Humidity (RH)	
Sensor	Sensirion SHT35
DB temperature accuracy	
68°F to 140°F (20°C to 60°C)	±0.18°F (±0.1°C)
32°F to 68°F (0°C to 20°C)	±0.36°F (±0.2°C)
DB temperature sensor long term drift	<0.054°F/yr (0.03°C/yr)
DB temperature operating temperature range <small>note 3</small>	-40 to +257°F (-40 to +125°C)
RH accuracy	±1.5%
RH sensor long term drift	<0.25%/yr
RH operating range <small>note 3</small>	0 - 100% RH

Dew-point temperature	
Dew-point temp. is evaluated from RH and DB temp.	Magnus formula
Dew-point accuracy	
74°F @40% RH (23°C @40% RH)	±1.35°F (±0.75°C)
74°F @50% RH (23°C @50% RH)	±1.2°F (±0.67°C)
74°F @60% RH (23°C @60% RH)	±1.1°F (±0.61°C)

Digital gas sensor for monitoring indoor air quality	
Sensor	AMS CCS811
Volatile Organic Compounds (VOC) detected	Alcohols, Aldehydes, Ketones, Organic Acids, Amines, Aliphatic and Aromatic Hydrocarbons
Early-Life Use (Burn-In)	48h
Conditioning Period (Run-In)	20m
Sample rate (default)	60 seconds
Temperature operating range <small>note 3</small>	23°F to +122°F (-5°C to +50°C)
RH operating range <small>note 3</small>	10 to 95% RH

Communication

Interface Standard	2-wire RS-485
Communication protocols	Modbus or BACnet <small>note 2</small>

Input power

24 V AC/DC (±15%)	0.6VA / 0.4W
-------------------	--------------

Size and weight note 4

Size

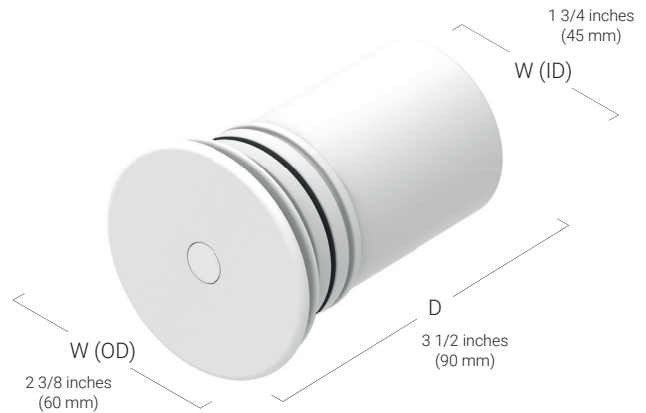

Weight 2 ounces (57 grams)

Wall protrusion 5/16 (8 mm)

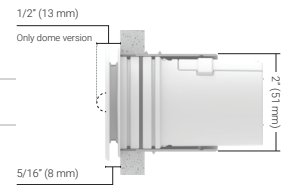

Mounting type

O-in™ mounting technology (requires 2-inch hole drywall cut out)

User interaction

App or web interface note 1

Programming

Dip-switch, Near Field Communication (NFC), serial bus RS485 (Modbus or BACnet) note 2

Color and finish

Arctic white paintable plastic

Environmental requirements

Operating ambient temperature	32° to 120°F (0° to 50°C)
Relative humidity	0% to 100%
Operating altitude	up to 10,000 feet (3,000 m)

In the box

mSense, documentation. Installation kit to be ordered separately.

Lifetime

Expected sensor lifetime is 10 years or more, in normal RH and temperature operating range. Over the years the accuracy of integrated sensors will decrease based on the long term drift.

Notes

1. App and Web Interface are available only with a Messana home climate control system.
2. Modbus or BACnet protocols can be selected via dip-switch (#9). BACnet will be available late in 2017.
3. Related to the embedded sensor, not to the mSense itself. See also "Environmental requirements".
4. Size, weights and technical characteristics may vary without prior notice.

Installation Guide

in the most simple way

In the box

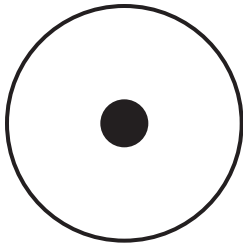

mSense

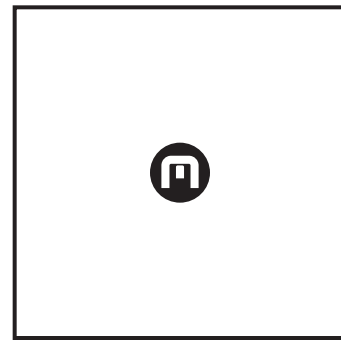

mSense Installation Guide

Installation kit (sold separately)

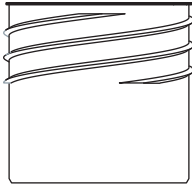

O-in™ drywall adapter sleeve

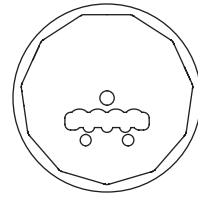

Mudding / Painting
O-in™ protection cap

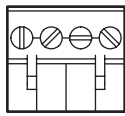

mSense plug connector

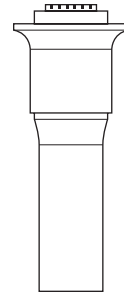

O-in™ insertion tool
(use with adapter sleeve)



mSense sensors should be installed by a professional.

Installation and positioning guidelines

mSense is the “eye” of the control system. In order to “see” the thermal radiations of the room the sensor must have an unobstructed view. An incorrect positioning of the sensor will prevent the heating and cooling system from delivering the best thermal comfort.

- mSense should be installed from 5ft to 7ft from the floor.
- Choose an internal wall and a central location and avoid direct exposition to sunlight and air drafts.
- Avoid locations where the sensor can be covered by furniture, doors, draperies and clothing.
- It must always be installed away from any equipment that could generate heat, cold and humidity.

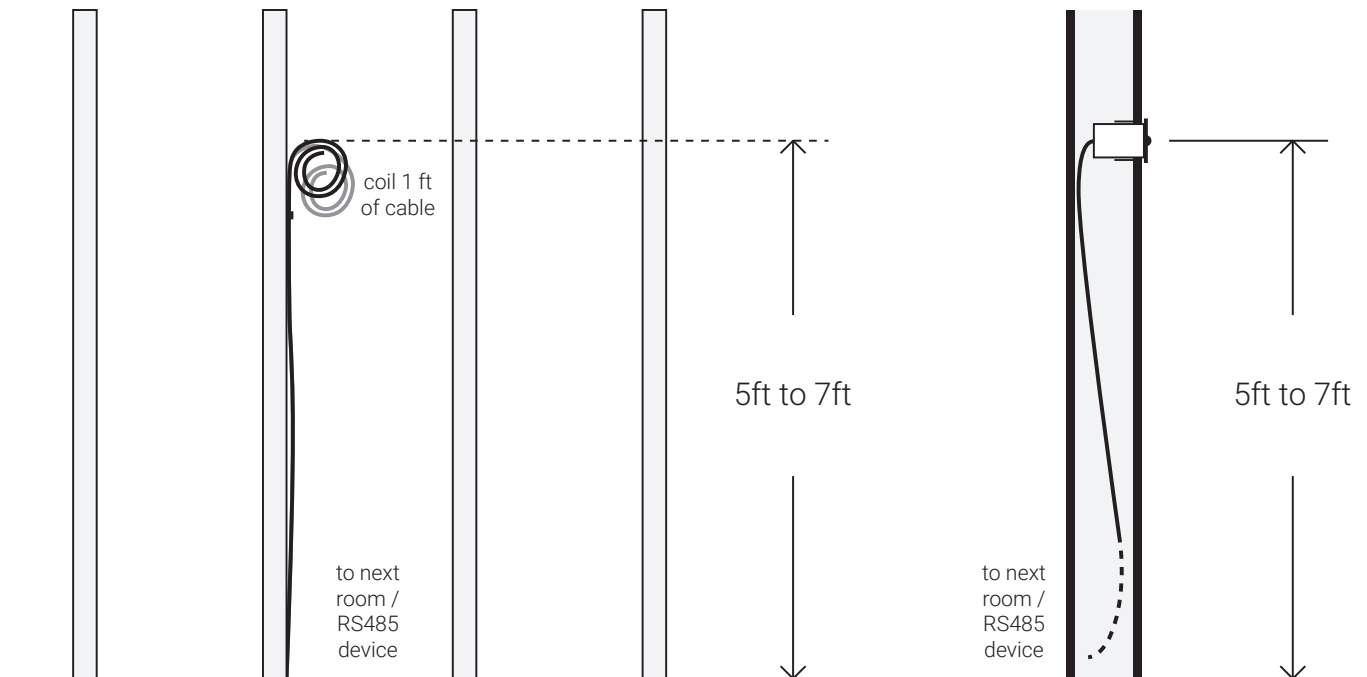

Before drywall is installed, run two wires in a daisy chain configuration through the studs. Staple the wires to a wall stud (5 to 7 feet) above the floor and coil 1 foot of the wire within the wall cavity. Mark the location of the wires in order to be able to locate them after the drywall is installed. This method requires locating the wire in the wall cavity after dry walling has been completed. A preferred method is to mount a 16x16 square of sheet rock along with the metal sleeve and sheet rocking the rest of the room later.

Drywall cut out (2-inch)

Attach a drywall patch (16"x10" recommended size) between the studs (be careful to center it from 5 to 7ft from the finished floor).

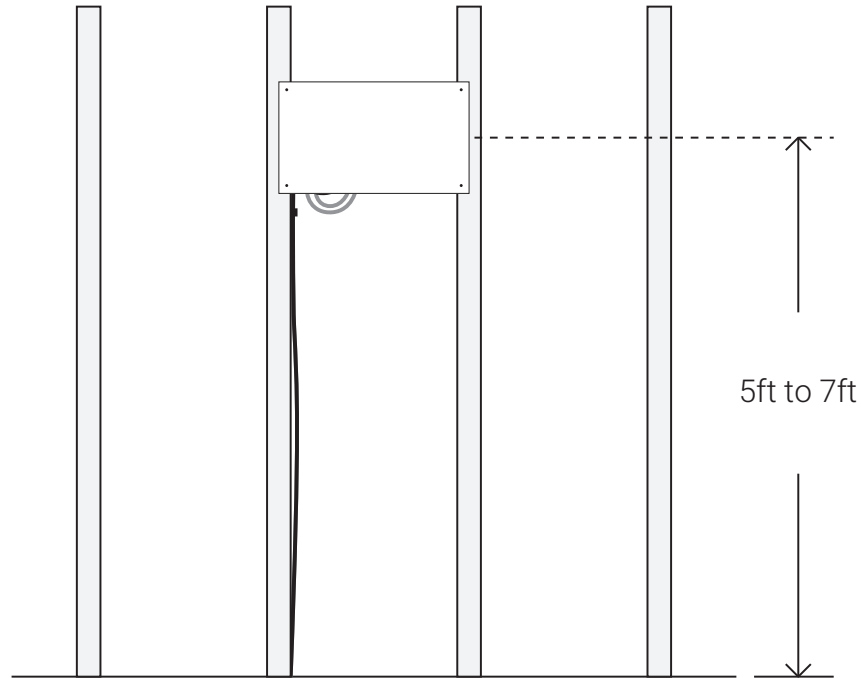

Using a drill and a 2" hole saw cut a round hole in the drywall patch and proceed with the installation of the O-in™ adapter sleeve as shown in the section "O-in™ adapter sleeve installation sequence".

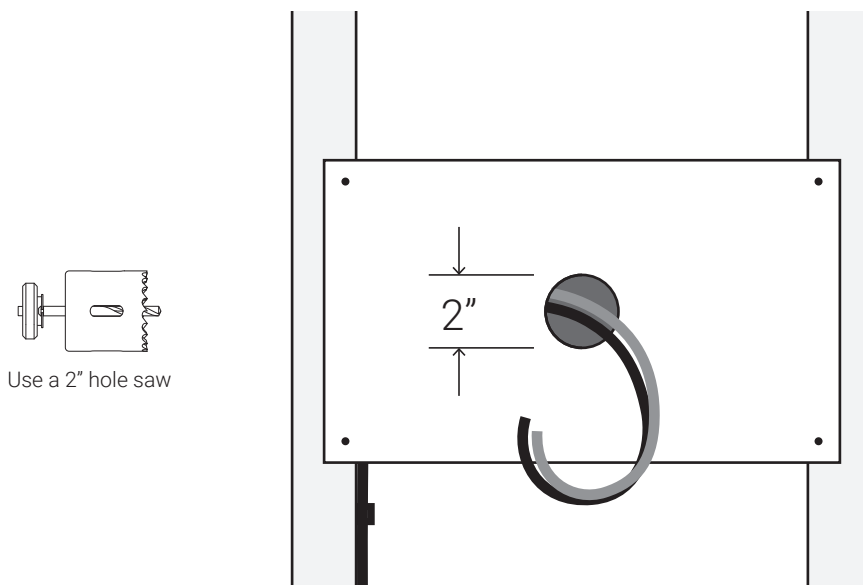

i If the sensor is mounted over a Messana mPad or a regular wall switch or receptacle, pay attention to the alignment with the mSense sensor.

! When cutting the 2" hole pay attention to pipes and or wires behind the drywall patch.

O-in™ adapter sleeve installation kit



O-in™ adapter sleeve

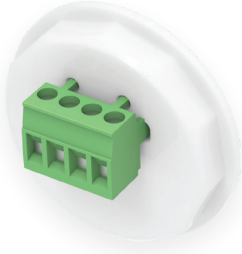

Mudding / painting O-in™ protection cap and plug connector

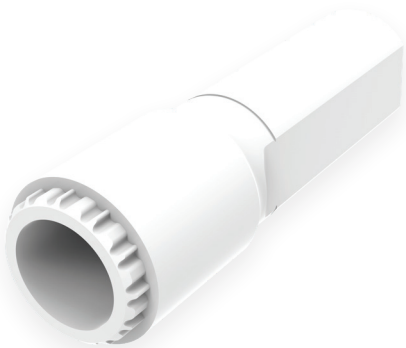

O-in™ installation tool



O-in™ installation housing

O-in™ adapter sleeve installation sequence



- 1 Pass the cables inside the O-in™ adapter sleeve and insert them inside the O-in™ installation tool. Fix the O-in™ adapter sleeve through the little slots into the O-in™ installation tool (the threaded part goes toward the tool).

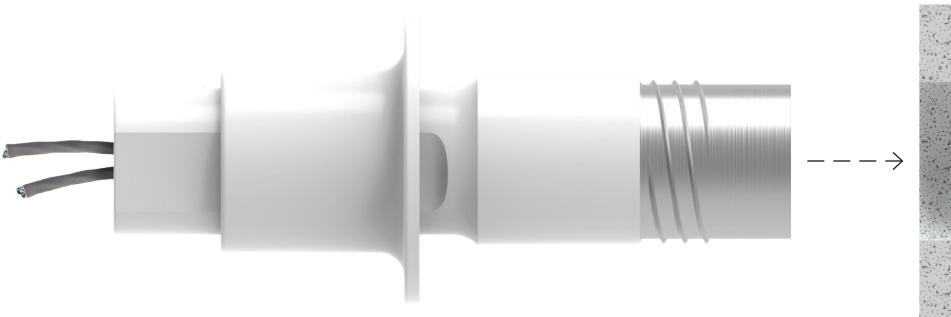

- 2 Push the O-in™ adapter sleeve into the wall up to the start of the threads. Push the O-in™ installation housing against the drywall in order to maintain a perpendicular position.

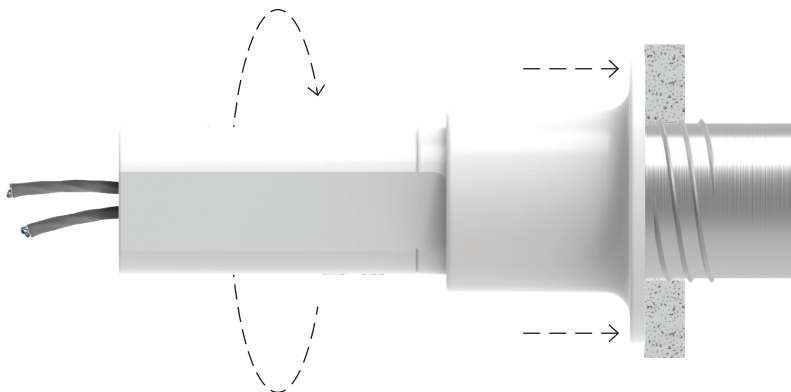

- 3 Firmly hold the O-in™ installation housing against the drywall surface in order to maintain the tool's perpendicularity. Push and rotate in a clockwise direction until the O-in™ installation tool adapter sleeve is completely screwed into the drywall. Remove the installation tool.

Wiring the 4-pole connector

The two 2-pair twisted cables must be connected together into the 4-pole connector to maintain a daisy chain connection. Using a wire-stripping tool strip all stranded wire about 1/4 inch from the end. Couple the wires with same color and line up their ends, then twist the terminals together. Insert the 4 couples into the 4-pole connector following the label and tighten the screws.

💡 Before wiring the mSense sensor, make sure to set the communication parameters (serial address, termination and protocol) through the dip-switch. See section “Dip-switch configurations”.

ⓘ In case of first or end terminal of the daisy chain there will be only one cable to be wired. Follow the same wiring instruction.

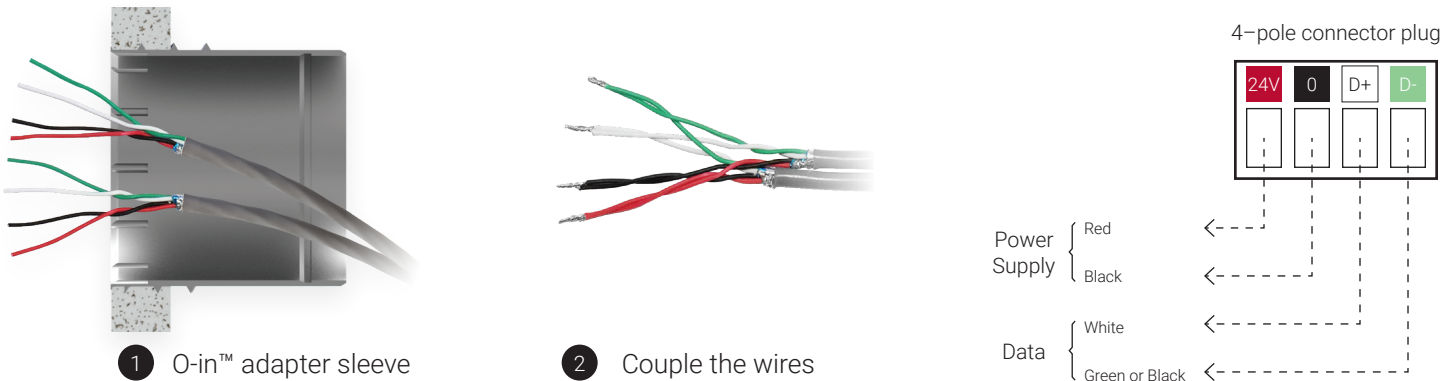

Insert the plug connector into the O-in™ protection cap.

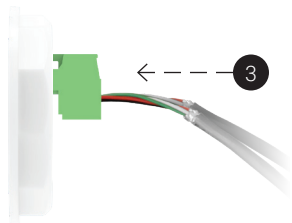

Push the mudding / painting O-in™ protection cap into the sleeve.

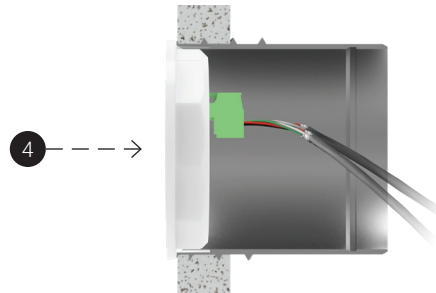

ⓘ The plastic protection cap holds the wired connector in place and protects it from dust and debris during all the construction phases.

Cable specifications

Type: Communication and control cable

Option 1: 22 AWG twisted pair foil shielded, 24 AWG drain wire (data) - 18 AWG pair (power)

Option 2: 22 AWG 2-pair twisted, individually foil shielded, 24 AWG drain wire

Option 3: 22 AWG 2-pair twisted

Option 1, Option 2 and Option 3 are suitable for residential.

For commercial applications Option 1 or Option 2 is required.

⚠️ If the environment is not electrically noisy, the shield can be left off. In electrically noisy environments, the shield must be connected. Only one end of the cable shield should be grounded to prevent ground loops.

Approved cables

22 AWG twisted pair foil shielded, 24 AWG drain wire (data) - 18 AWG pair (power)

Manufacturer	Code	Pair Color	24V	0	D+	D-
Lutron Cable	GRX-CBL-346S	red & black / white & purple	■	■	□	■

22 AWG 2-pair twisted, individually foil shielded, 24 AWG drain wire

Manufacturer	Code	Pair Color	24V	0	D+	D-
Belden	8723	red & black / white & green	■	■	□	■
Alpha Wire	2466C	red & black / white & green	■	■	□	■
General Cable	C1352A	red & black / white & green	■	■	□	■
General Cable	C4203A	red & black / white & green	■	■	□	■

22 AWG 2-pair twisted

Manufacturer	Code	Pair Color	24V	0	D+	D-
Alpha Wire	1317C	red & black / white & black	■	■	□	■
General Cable	C6010A	red & black / white & black	■	■	□	■

mSense communication protocol

Communication between mSense and the Messana controls (mZone, mBox) or third party control systems is carried by a serial RS-485 interface. The interface is EIA RS-485 compliant. The RS-485 bus provides a communication over a twisted pair wire. If the sensor is not powered locally (at the installation position), an additional twisted pair wire is needed for the power supply (24VAC/DC). In this case, Messana suggests to use a 22 AWG 2-pair twisted cable; one pair is used for the communication bus and the second pair for the power supply.

The bus must be linear and branches are not allowed, in accordance with the RS-485 bus specification. Therefore, with the exception of the first and the last one, all the sensors on the bus are connected to a pair of cables. The sensors placed at the two ends of the bus must be configured with their Dip-switch #0 in the ON position, in order to properly terminate the bus. See section "Setting the mSense address" for details.

The sensors are set in the factory with the following default communication settings:

- Speed: 9600
- Parity: none
- Data bits: 8
- Stop bits: 1

The following settings are user configurable:

- Speed: 1200, 2400, 4800, 9600 (default), 19200, 38400
- Parity: none (default), odd, even or mark

When the mSense sensor are powered over the bus (22AWG 2-pair twisted cable), the maximum number of mSense devices is 12 per bus branch, and the maximum bus length must satisfy the following conditions:

- if the power for the mSense is supplied from the bus end, the maximum length is 300ft;
- if the power for the mSense is supplied from an intermediate bus segment, the 300ft max length is applied to each segment.

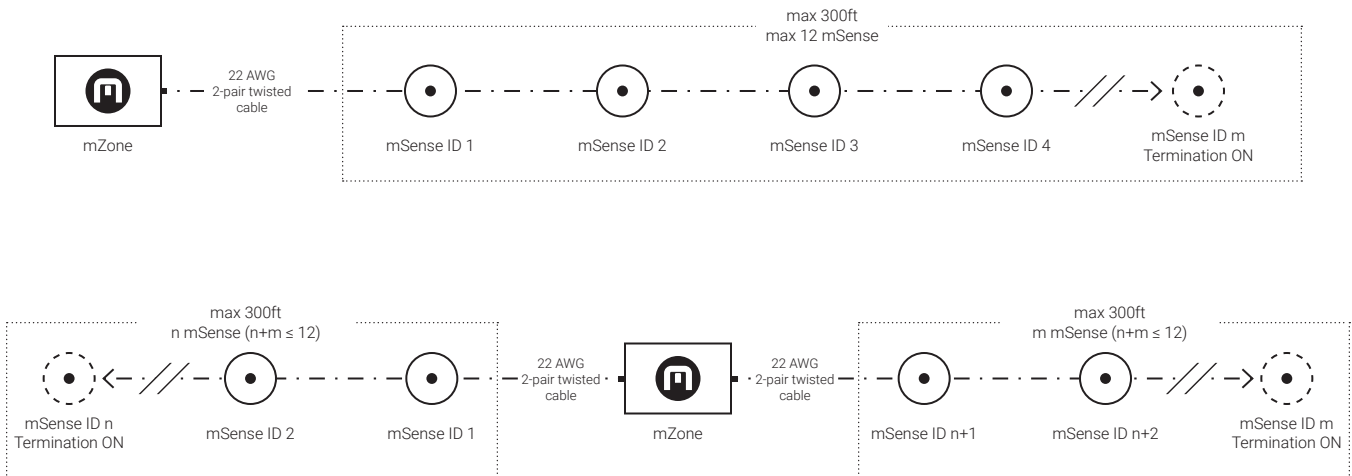

When the mSense sensors are locally powered, the maximum number of physical mSense devices connected to the serial bus is 64, unless further restricted by other third party devices present on the same bus. Bus extenders can be used to overcome the 64 device limitation (not supplied by Messana).

Setting the mSense address

A Modbus RS-485 network comprises of one Master device (e.g. Messina mZone zoning module) and up to 247 Slave devices (e.g. mSense sensors).

A Slave device can communicate on the bus only if requested by the Master.

Therefore, a typical Modbus (or BACnet) transaction involves the Master, who is in charge of controlling the bus, and one Slave device at a time. Additionally, the Master can also broadcast messages to all the Slaves.

In order to identify the recipient of the message, the first character is a byte that contains the numeric address of the designated Slave.

It is of the uttermost importance that each Slave device must be configured with a unique numeric address. Eligible addresses are 1 through 247.

i Address 0 cannot be assigned to a Slave.

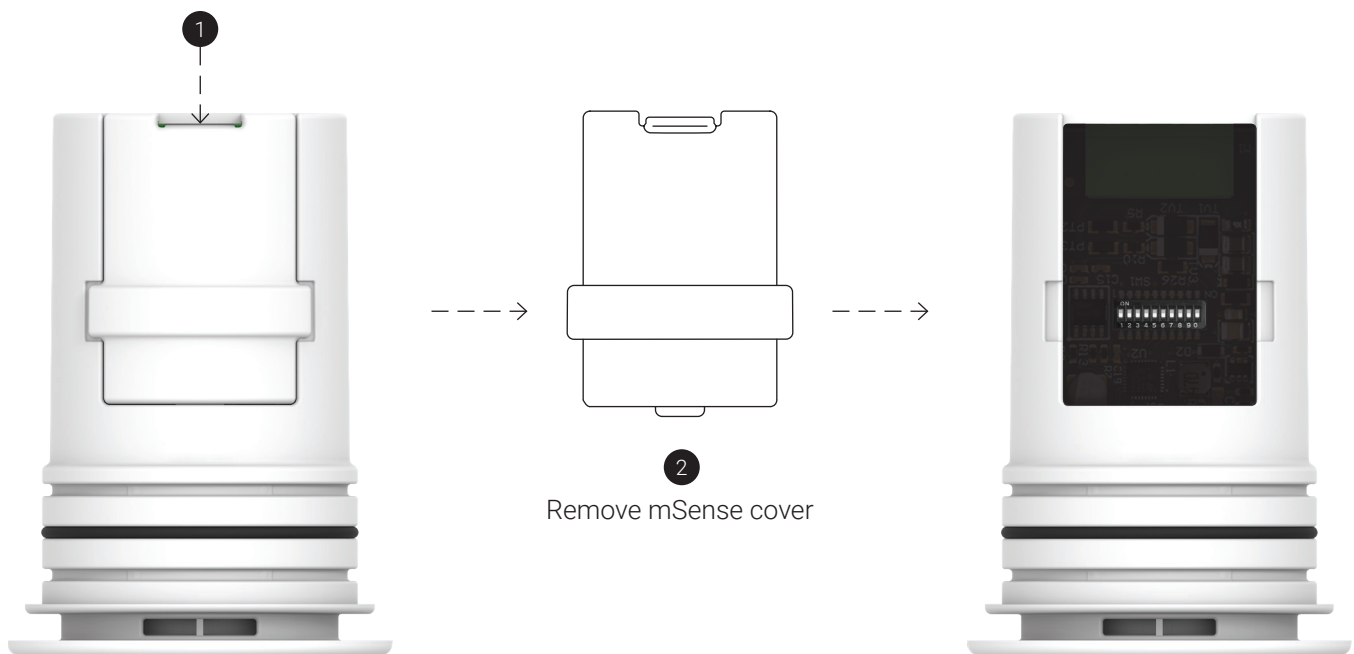

The Slave address must be manually configured through the dip-switch SW1. The dip-switch can be accessed by removing the mSense top cover as show in the pictures above.

The dip-switch SW1 must be set according to the diagram in the section “Dip-switch configurations”.

Dip-switch configurations

mSense address (dip-switch #1 to #8)



Bus termination (dip-switch #0)

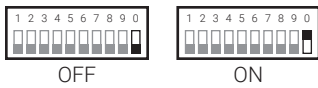

Modbus / BACnet protocol selection (dip-switch #9)

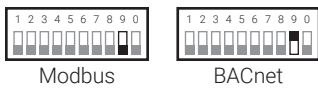

Finishing the installation with O-in™ mount technology

To complete the installation of the mSense sensor, remove the O-in™ protection cap from the wall. Use a sharp tool to carefully lift the edge or insert the end of a paper clip and pull it out. Extract the previously wired connector and plug it to the mSense sensor.

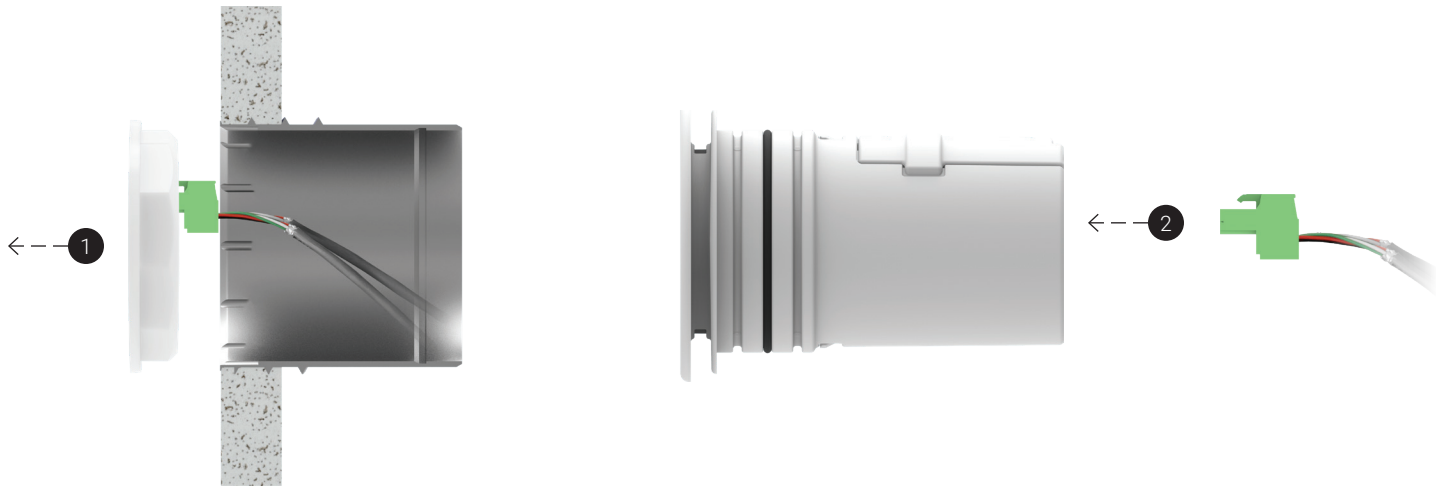

Push the mSense into the O-in™ adapter sleeve. Make sure to align the air openings vertically as shown in the picture. During insertion be sure to keep the ventilation holes on the front of the mSense sensor perpendicular to the floor as shown in the picture.

i Depending on the wall finishing, to ensure the correct grip of the sensor you may need to move the o-ring.

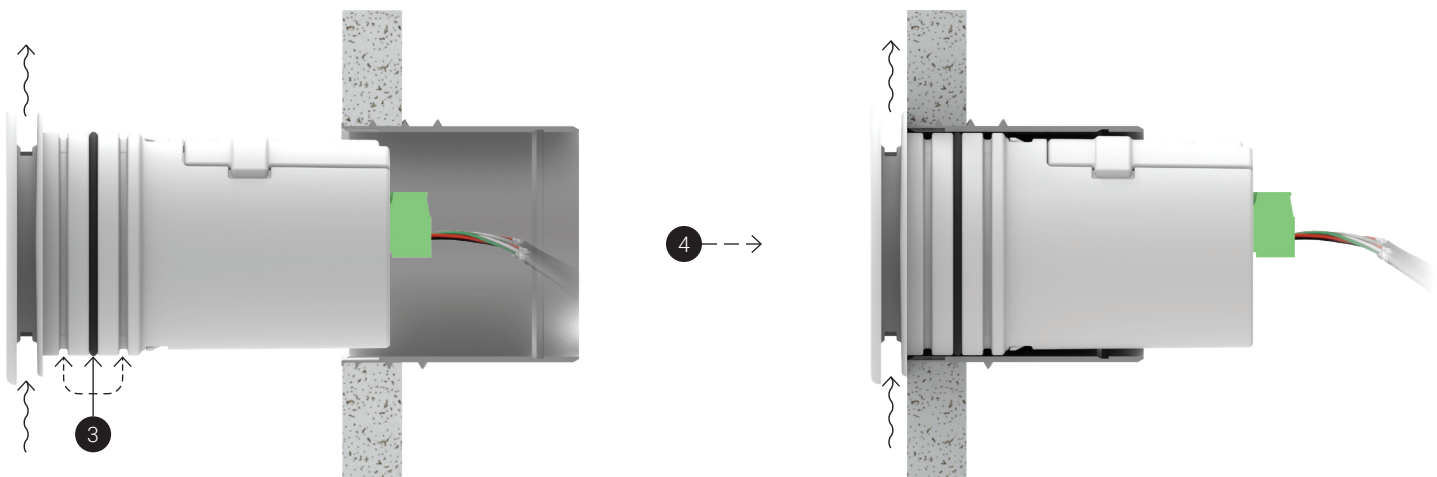

Design without distractions

Even untouched mSense is barely noticeable. To make the sensor even less noticeable mSense can be painted using water based paint in a matte finish only. Oil based or gloss and semi-gloss paint can have an effect on the accuracy of the readings performed by the sensors, so please do not use these products on the sensor face. It is also critical to NOT obscure the openings in the sensor in any way.

Following these parameters will provide a tool that you can barely see but gives you a lot of information.

With mSense, architects and interior designers have the freedom to develop their vision without having to incorporate large, unsightly thermostats that detract from the beauty of a space.

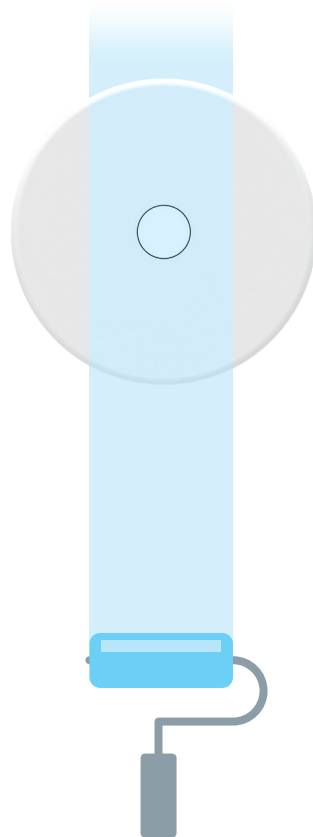

Messana Radiant Cooling typical system wiring diagram

Wiring Legend

- mSense data/power cable (22 AWG 2-pair twisted cable)
- RS485 twisted pair
- Ethernet CAT 5

- DO Digital Outputs
 - DI Digital Inputs
 - AO Analog Outputs
 - AI Analog Inputs
- } use AWG18 twisted pair unless otherwise specified

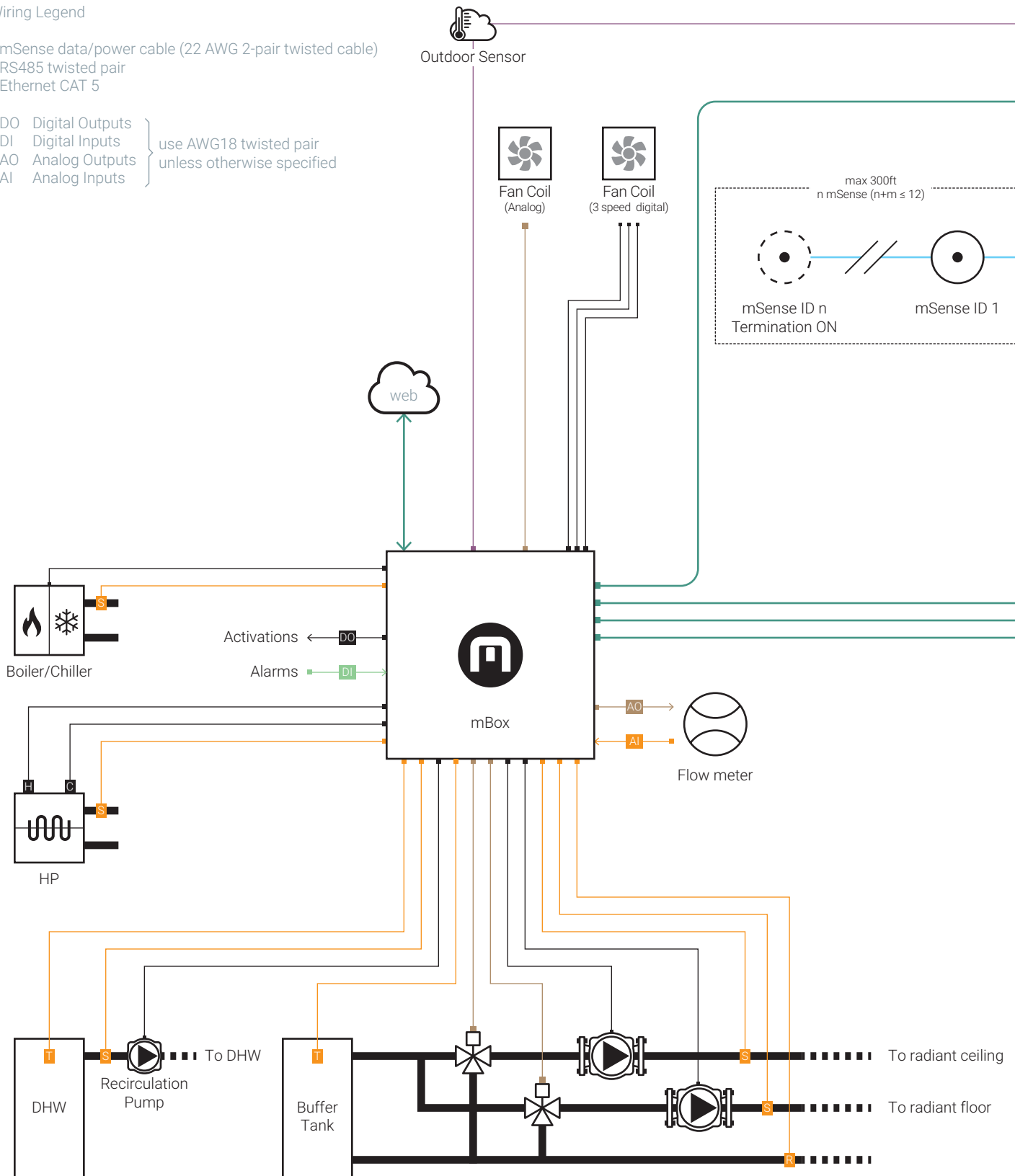

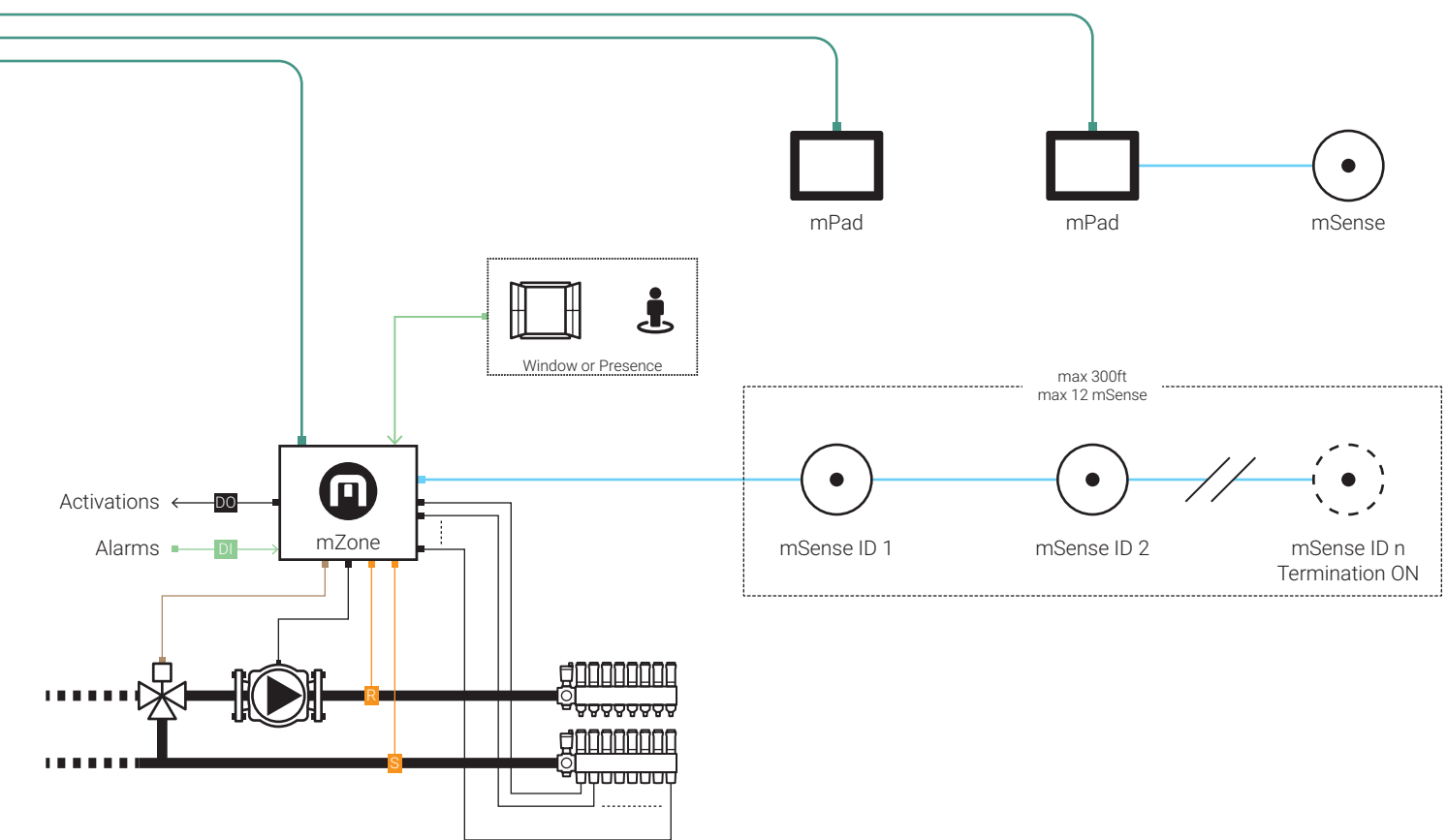
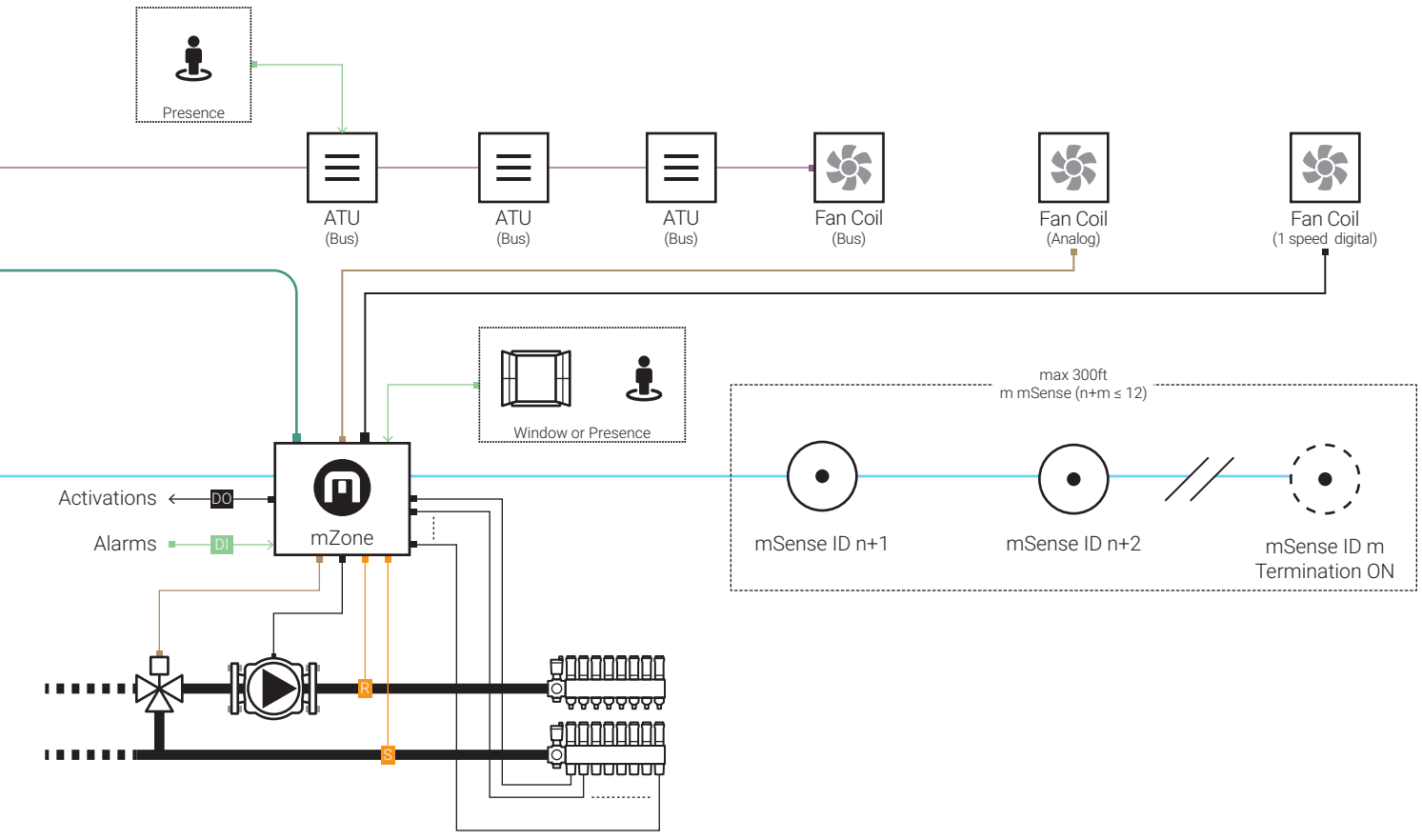

Modbus registers

mSense can communicate with a control system (e.g. Messina mZone) via Modbus protocol. The sensor programming and data exchange is based on three set of 16bit registers:

- General settings
- Data register, read only, with temperature in Fahrenheit degree
- Data register, read only, with temperature in Celsius degree

mSense is designed to work with both Fahrenheit and Celsius degrees.

The Modbus registers can be read with the command 0x03 (read holding register) and write with the commands 0x06 (write single register) and 0x10 (write multiple register).

If a value from one of the three sensors (STS30, SHT35 and CCS801) is unavailable, the data register returns 32768 (0x8000).

16bit registers (General settings)

Address		Information	Min	Max	Unit	R/W	Description
Dec	Hex						
200	0x00c8	Modbus address	0	247		R/W	Modbus address, room sensor identification number (ID). Each mSense on the serial bus must have a different identification number ^{note 1} .
201	0x00c9	Transmission speed	0	5	bit/s	R/W	Select on the following transmission speed values: 1200, 2400, 4800, 9600 (default 3) , 19200, 38400.
202	0x00ca	Parity	0	3		R/W	Value selectable between the following value: none (default 0) , odd, even or space.
203	0x00cb	Sensor type	10	12		R	Sensor type: 10 Temperature (only STS30 sensor on board) 11 Temperature and relative humidity (only STS30 and SHT35 sensor on board) 12 Temperature, relative humidity and IAQ (STS30, SHT35 and CCS801 sensor on board).
204	0x00cc	Air temp, Dew-point and RH sample rate	0	600	sec	R/W	Interval between two consecutive readings for the following SHT35 parameters: air temperature, dew-point temperature and temperature and relative humidity (default 60). 0 = no polling.
205	0x00cd	Operative T sample rate	0	600	sec	R/W	Interval between two consecutive readings of the operative temperature (default 60). 0 = no polling.
206	0x00ce	IAQ sample rate	0	600	sec	R/W	Interval between two consecutive readings of the following IAQ sensor parameters: eCO ₂ , TVOC and Raw IAQ (default 60). 0 = no polling.
207	0x00cf	HW version	0			R	Hardware version.
208	0x00d0	SW version	0			R	Software version.
209	0x00d1	LED	0	1		R/W	Led activity enabling.
210	0x00d2	S/N [0-1]	0	0xffff		R	ASCII code for serial number digit 0 and 1.
211	0x00d3	S/N [2-3]	0	0xffff		R	ASCII code for serial number digit 2 and 3.
212	0x00d4	S/N [4-5]	0	0xffff		R	ASCII code for serial number digit 4 and 5.
213	0x00d5	S/N [6-7]	0	0xffff		R	ASCII code for serial number digit 6 and 7.
214	0x00d6	S/N [8-9]	0	0xffff		R	ASCII code for serial number digit 8 and 9.
215	0x00d7	S/N [10-11]	0	0xffff		R	ASCII code for serial number digit 10 and 11.
216	0x00d8	S/N [12-13]	0	0xffff		R	ASCII code for serial number digit 12 and 13.
217	0x00d9	Operative T offset	-100 (0)	-10(0)	°C x 10	R/W	Offset for operative temperature (default 0).
218	0x00da	T air offset	-10(0)	-10(0)	°C x 10	R/W	Offset for air temperature (default 0).
219	0x00db	RH offset	-10(0)	-10(0)	°RH x 10	R/W	Offset for relative humidity (default 0).

16bit registers (Fahrenheit degree)

Address		Information	Min	Max	Unit	R/W	Description
Dec	Hex						
0	0x0000	Operative temperature	-400 (-40.0°F)	1940 (194.0°F)	°F x 10	R	Operative temperature measured by the Sensirion STS30 sensor placed in the metal dome (or flat capsule).
1	0x0001	Air temperature	-400 (-40.0°F)	1940 (194.0°F)	°F x 10	R	Dry bulb air temperature of the air flowing through the mSense air openings. Measured by the sensor Sensirion SHT35.
2	0x0002	Dew-point temperature	-1260 (-126.0°F)	1940 (194.0°F)	°F x 10	R	Dew-point temperature calculated with the Magnus formula based on the dry bulb air temperature and relative humidity.
3	0x0003	Relative humidity	0 (0%)	1000 (100.0%)	%RH x 10	R	Relative humidity, read by the sensor placed in the right side of the electronic board (Sensirion SHT35).
4	0x0004	Equivalent CO ₂	400	8192	ppm	R	Equivalent Carbon dioxide (eCO2) level read by the IAQ sensor (CCS801).
5	0x0005	TVOC	0	1187	ppb	R	Total Volatile Organic Compounds level read by the IAQ sensor (CCS801).
6	0x0006	Raw IAQ	0 / 0	63 / 'na	µA / V	R	Readings of the current through the sensor resistor (most significant 6 bits) and voltage across the sensor resistor (lower 10 bits, example 1023 = 1.65V).
7	0x0007	Errors	0	.	-	R	Sensor error – bitmap ^{note 2} bit 0 – operative temperature sensor failure bit 1 – operative temperature sensor out of range bit 2 – air temperature sensor failure bit 3 – air temperature sensor out of range bit 4 – RH sensor failure bit 5 – RH sensor out of range bit 6 – CO2 sensor failure bit 7 – CO2 sensor out of range bit 8 – VOC sensor failure bit 9 – VOC sensor out of range bit 10 – generic failure ^{note 3}

16bit registers (Celsius degree)

Address		Information	Min	Max	Unit	R/W	Description
Dec	Hex						
100	0x0064	Operative temperature	-400 (-40.0°F)	1940 (194.0°F)	°F x 10	R	Operative temperature measured by the Sensirion STS30 sensor placed in the metal dome (or flat capsule).
101	0x0065	Air temperature	-400 (-40.0°F)	1940 (194.0°F)	°F x 10	R	Dry bulb air temperature of the air flowing through the mSense air openings. Measured by the sensor Sensirion SHT35.
102	0x0066	Dew-point temperature	-1260 (-126.0°F)	1940 (194.0°F)	°F x 10	R	Dew-point temperature calculated with the Magnus formula based on the dry bulb air temperature and relative humidity.
103	0x0067	Relative humidity	0 (0%)	1000 (100.0%)	%RH x 10	R	Relative humidity, read by the sensor placed in the right side of the electronic board (Sensirion SHT35).
104	0x0068	Equivalent CO ₂	400	8192	ppm	R	Equivalent Carbon dioxide (eCO2) level read by the IAQ sensor (CCS801).
105	0x0069	TVOC	0	1187	ppb	R	Total Volatile Organic Compounds level read by the IAQ sensor (CCS801).
106	0x006a	Raw IAQ	0 / 0	63 / na	µA / V	R	Readings of the current through the sensor resistor (most significant 6 bits) and voltage across the sensor resistor (lower 10 bits, example 1023 = 1.65V).
107	0x006b	Errors	0	.	-	R	Sensor error – bitmap ^{note 2} bit 0 – operative temperature sensor failure bit 1 – operative temperature sensor out of range bit 2 – air temperature sensor failure bit 3 – air temperature sensor out of range bit 4 – RH sensor failure bit 5 – RH sensor out of range bit 6 – CO2 sensor failure bit 7 – CO2 sensor out of range bit 8 – VOC sensor failure bit 9 – VOC sensor out of range bit 10 – generic failure ^{note 3}

Notes

1. Modbus address can also be set via dip-switch, however the Modbus or Near Field Communication (NFC) programming overwrite the dip-switch setting.
2. Bit 2 and bit 4 return the same value since both refer to the same sensor (Sensirion SHT35). The same applies to bit 6 and bit 8 for the IAQ sensor (CCS801).
3. Depending on the device characteristics and the self-diagnosis capabilities.

Explore the latest home climate control technology Designed by Messana specifically for Radiant Cooling and Heating Systems

Messana offers a unique home climate control platform designed with 20-year experience in hydronic radiant cooling and heating. The Messana control system integrates a unique technology to modulate radiant fluid temperatures so that surfaces stay above the dew-point, while keeping occupants comfortable and boosting energy efficiency.



mBox

HVAC/Radiant automation and control module

It is the main unit of the home climate control system. Typically installed in the mechanical room, it regulates the home energy flow to deliver optimal Thermal Wellbeing™.

It controls energy resources (heat pumps, chillers and boilers) with multi-staging, Domestic Hot Water, Heat Recovery Ventilation based on Indoor Air Quality and Neutral Temperature Dehumidification.



mZone

zoning module (available for 8 or 12 zones)

The mZone module connects up to 12 mSense room sensors. It is installed at manifold location to activate thermal actuators, recirculating pumps, mixing valves, 2-way and 6-way zone valves and air handlers. It is designed for 2-pipe as well as for 4-pipe distribution systems for simultaneous heating and cooling demand. It works also with hybrid radiant/forced-air cooling and heating systems.

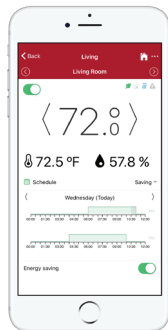

Messana App

web and mobile full-system control app

The new Messana web and mobile app, gives you full control of the radiant cooling and heating system from anywhere in the world. It features a friendly and intuitive user interface to interact even with the most sophisticated systems at your fingertips.

The Messana app fits seamlessly in your life to provide the perfect Thermal Wellbeing™, precisely when and where you want it.

Warranty Conditions

LIMITED WARRANTY AND PRODUCT RETURN PROCEDURE

The liability of Messina under this warranty is limited.

The Purchaser, by taking receipt of any Messina product ("Product"), acknowledges the terms of the Limited Warranty in effect at the time of such Product sale and acknowledges that it has read and understands same.

The Messina Limited Warranty to the Purchaser on the Products sold hereunder is a manufacturer's pass-through warranty which the Purchaser is authorized to pass through to its customers. Under the Limited Warranty, each Messina Product is warranted against defects in workmanship and materials if the Product is installed and used in compliance with Messina's instructions, ordinary wear and tear excepted. The pass-through warranty period is for a period of twenty-four (24) months from the production date if the Product is not installed during that period, or twelve (12) months from the documented date of installation if installed within twenty-four (24) months from the production date.

The liability of Messina under the Limited Warranty shall be limited to, at Messina's sole discretion: the cost of parts and labor provided by Messina to repair defects in materials and/or workmanship of the defective product; or to the exchange of the defective product for a warranty replacement product; or to the granting of credit limited to the original cost of the defective product, and such repair, exchange or credit shall be the sole remedy available from Messina, and, without limiting the foregoing in any way, Messina is not responsible, in contract, tort or strict product liability, for any other losses, costs, expenses, inconveniences, or damages, whether direct, indirect, special, secondary, incidental or consequential, arising from ownership or use of the product, or from defects in workmanship or materials, including any liability for fundamental breach of contract.

The pass-through Limited Warranty applies only to those defective Products returned to Messina during the warranty period. This Limited Warranty does not cover the cost of the parts or labor to remove or transport the defective Product, or to reinstall the repaired or replacement Product, all such costs and expenses being subject to Purchaser's agreement and warranty with its customers.

Any representations or warranties about the Products made by Purchaser to its customers which are different from or in excess of the Messina Limited Warranty are the Purchaser's sole responsibility and obligation. Purchaser shall indemnify and hold Messina harmless from and against any and all claims, liabilities and damages of any kind or nature which arise out of or are related to any such representations or warranties by Purchaser to its customers.

The pass-through Limited Warranty does not apply if the returned Product has been damaged by negligence by persons other than Messina, accident, fire, Act of God, abuse or misuse; or has been damaged by modifications, alterations or attachments made subsequent to purchase which have not been authorized by Messina; or if the Product was not installed in compliance with Messina's instructions and/or the local codes and ordinances; or if due to defective installation of the Product; or if the Product was not used in compliance with Messina's instructions.

THIS WARRANTY IS IN LIEU OF ALL OTHER WARRANTIES, EXPRESS OR IMPLIED, WHICH THE GOVERNING LAW ALLOWS PARTIES TO CONTRACTUALLY EXCLUDE, INCLUDING, WITHOUT LIMITATION, IMPLIED WARRANTIES OF MERCHANTABILITY AND FITNESS FOR A PARTICULAR PURPOSE, DURABILITY OR DESCRIPTION OF THE PRODUCT, ITS NON-INFRINGEMENT OF ANY RELEVANT PATENTS OR TRADEMARKS, AND ITS COMPLIANCE WITH OR NON-VIOLATION OF ANY APPLICABLE ENVIRONMENTAL, HEALTH OR SAFETY LEGISLATION; THE TERM OF ANY OTHER WARRANTY NOT HEREBY CONTRACTUALLY EXCLUDED IS LIMITED SUCH THAT IT SHALL NOT EXTEND BEYOND TWENTY-FOUR (24) MONTHS FROM THE PRODUCTION DATE, TO THE EXTENT THAT SUCH LIMITATION IS ALLOWED BY THE GOVERNING LAW.

RETURN PROCEDURE

All Products that are believed to have defects in workmanship or materials must be returned, together with a written description of the defect, to the Messina Representative assigned to the territory in which such Product is located. If Messina receives an inquiry from someone other than a Messina Representative, including an inquiry from Purchaser (if not a Messina Representative) or Purchaser's customers, regarding a potential warranty claim, Messina's sole obligation shall be to provide the address and other contact information regarding the appropriate Representative.

VARIATIONS THAT MIGHT APPLY TO THIS LIMITED WARRANTY

Some jurisdictions do not allow limitations on how long an implied warranty lasts or specific exclusions, so some of the limitations set out above may not apply to you. If any court or relevant authority decides that any of these limitations is unenforceable, it should be deemed modified to the minimum extent necessary to make it enforceable. If this modification is not possible, the relevant provision should be deemed deleted. Any modification or deletion will not affect the validity of the rest of this Limited Warranty.

CONTACT INFORMATION

Please direct any questions about this Limited Warranty to Messina Inc. at the address located at: radiantcooling.com/contact.

Colophon

designed in California & made in Italy

copyright © 2017 by Messana Radiant Cooling

All Rights reserved.

Messana Radiant Cooling
4105 Soquel Dr, Suite B
Soquel, CA 95073
USA

radiantcooling.com



Messana Radiant Cooling - 4105 Soquel Dr, Suite B - Soquel, CA 95073 - USA