

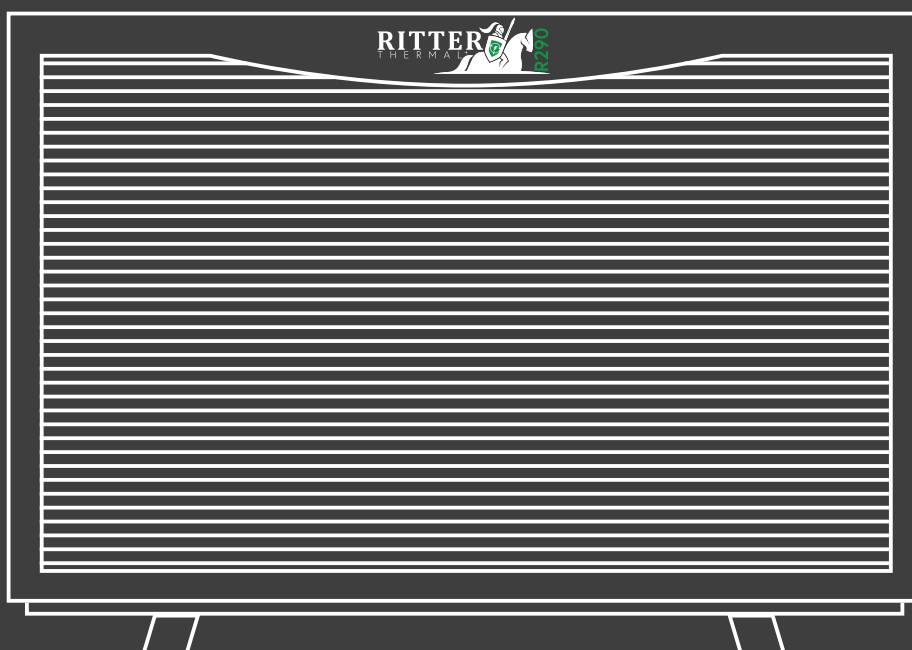

*Powered by Waterware*



## R290 AIR TO WATER HEAT PUMP



Installation and Instruction Manual

HPRP12HT • HPRP18HT

  
WATERWARE

[waterware.co.nz](http://waterware.co.nz)

# Content

Model Specification .....	3
Unit Dimensions .....	4
Exploded View .....	6
Capacities .....	8
Water Pump Performance .....	10
Electrical Information .....	12
Switches and Sensors .....	13
Installation Instructions/Requirements .....	14
Water System Installation .....	18
Electrical Wiring .....	19
Terminal Block Port Introduction .....	21
Unit Operation .....	25
Wire Controller (TFT) .....	29
Interface .....	29
Mode Setting .....	30
Silent Mode .....	31
Powerful Mode .....	31
Sterilization Mode .....	32
Parameter Setting .....	32
SG Ready Setting .....	33
Running Status Query .....	34
Factory Reset .....	35
APP & Unit Binding .....	35
Networking (AP Mode) .....	38
Error Codes .....	40
Parameters & Explanations .....	45

**Unit General Information**  
**Appearances**

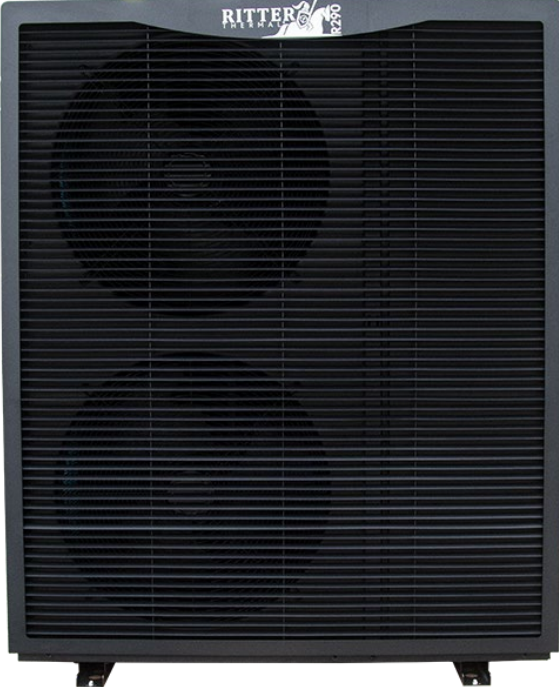
<b>Model</b>	<b>HPRP12HT</b>
Picture	 A black, rectangular portable heater with a front grille. The top of the grille features the Ritter logo and the text "RITTER 12000 BTU". The unit is supported by two small feet at the bottom.
<b>Model</b>	<b>HPRP18HT</b>
Picture	 A black, rectangular portable heater, similar in design to the HPRP12HT but larger. It features a front grille with the Ritter logo and "18000 BTU" printed at the top. The unit is supported by two small feet at the bottom.

## Model Specification

Model	Unit	HPRP12HT	HPRP18HT
Power Supply	/	220-240~/50Hz	
<b>Test Standard: EN14511 Ambient Temperature: 7°C/6°C (DB/WB), Water Inlet/Outlet: 30°C/35°C</b>			
Heating Capacity Min./Max	kW	4.30-15.20	7.24-22.10
Power Input Min./Max	kW	0.87-3.73	1.50-5.88
Rated Heating Capacity	kW	12.05	18.01
COP	/	4.62	4.4
<b>Test Standard: EN14511 Ambient Temperature: 7°C/6°C (DB/WB), Water Inlet/Outlet: 47°C/55°C</b>			
Heating Capacity Min./Max	kW	4.25-14.55	6.36-19.45
Power Input Min./Max	kW	1.45-4.28	2.15-6.85
Rated Heating Capacity	kW	12.18	18
COP	/	3.01	3.02
<b>Test Standard: EN14511 Ambient Temperature: 35°C/24°C (DB/WB), Water Inlet/Outlet: 12°C/7°C</b>			
Cooling Capacity Min./Max	kW	3.65-11.40	4.55-17.20
Power Input Min./Max	kW	1.12-3.97	1.85-7.31
Rated Cooling Capacity	kW	8.23	14.32
EER	/	2.59	2.44
<b>Test Standard: EN14511 Ambient Temperature: 35°C/24°C (DB/WB), Water Inlet/Outlet: 23°C/18°C</b>			
Cooling Capacity Min./Max	kW	4.56-13.03	5.59-22.36
Power Input Min./Max	kW	1.44-4.8	1.69-8.04
Rated Cooling Capacity	kW	10.43	17.89
EER	/	3.1	3.18
<b>Test Standard: EN14825-2022 Low temperature application(35°C)</b>			
SCOP	/	4.77	4.81
Energy Efficiency Class	/	A+++	A+++
<b>Test Standard: EN14825-2022 Medium temperature application(55°C)</b>			
SCOP	/	3.77	3.72
Energy Efficiency Class	/	A++	A++
<b>Operation Mode: Heating</b>			
Operating Range	°C	-25~35	
Water Outlet Temp. Range	°C	20~75	
<b>Operation Mode: Cooling</b>			
Operating Range	°C	15~45	
Water Outlet Temp. Range	°C	5~25	
<b>Operation Mode: DHW</b>			
Operating Range	°C	-25~45	
Water Outlet Temp. Range	°C	20~65	
<b>Test Standard: EN12102-2022 Ambient Temperature:7°C ,Water Outlet: 35°C</b>			
Sound Pressure Level	dB(A)	52	54
Sound Power Level	dB(A)	67	70
<b>Test Standard: EN12102-2022 Ambient Temperature:7°C ,Water Outlet: 55°C</b>			
Sound Pressure Level	dB(A)	53	54
Sound Power Level	dB(A)	68	70
Power Input Max.	kW	5.4	7.5
Current Input Max.	A	25	35
Refrigerant Type	/	R290	
Operation Pressure (Low Pressure Side)	MPa	0.8	

Model	Unit	HPRP12HT	HPRP18HT
Operation Pressure (High Pressure Side)	MPa	3.9	
Maximum Allowable Pressure	MPa	3.2	
Water Piping Connections	Inch	G1"	G1-1/4"
Expansion Tank	L	6	8
Water Pressure Drop	kPa	20	55
Water Pressure Min/Max	MPa	0.1/0.3	
Water Flow Rated	m <sup>3</sup> /h	2.06	3.1
Net Weight	Kg	128	192
Unpacked Weight	Kg	123	184

*Note: Parameters are subject to change without prior notice. Please refer to the unit nameplate.*

**Unit Dimensions  
HPRP12HT**

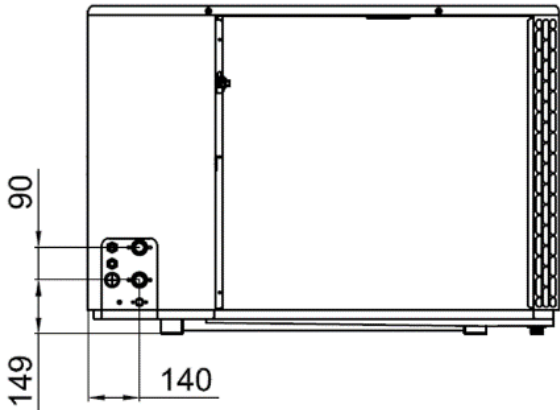
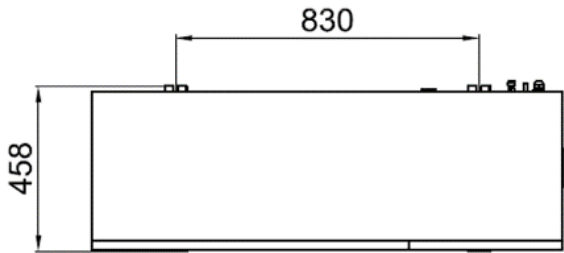
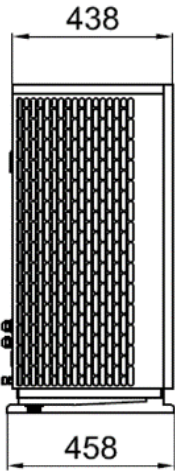
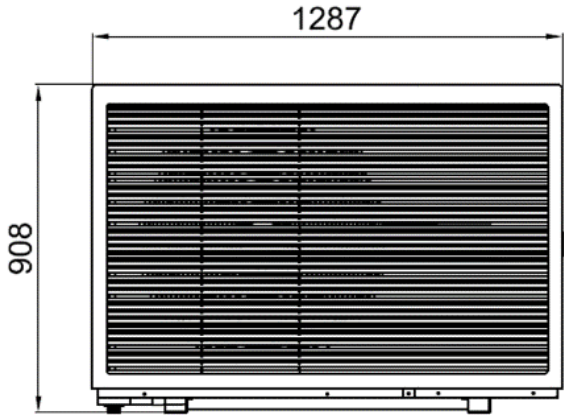

**Unit Dimensions**  
**HPRP18HT**

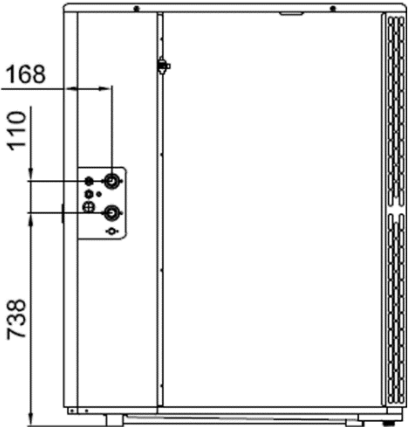
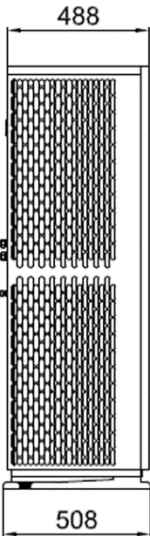
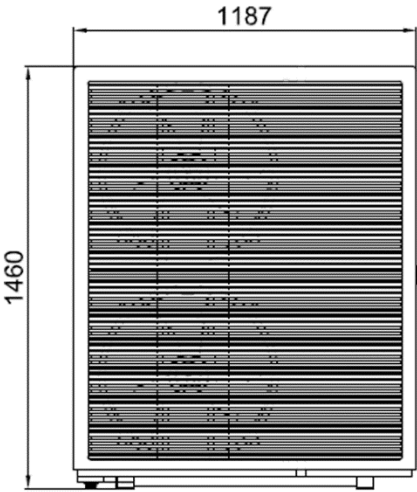

## Exploded View

### HPRP12HT

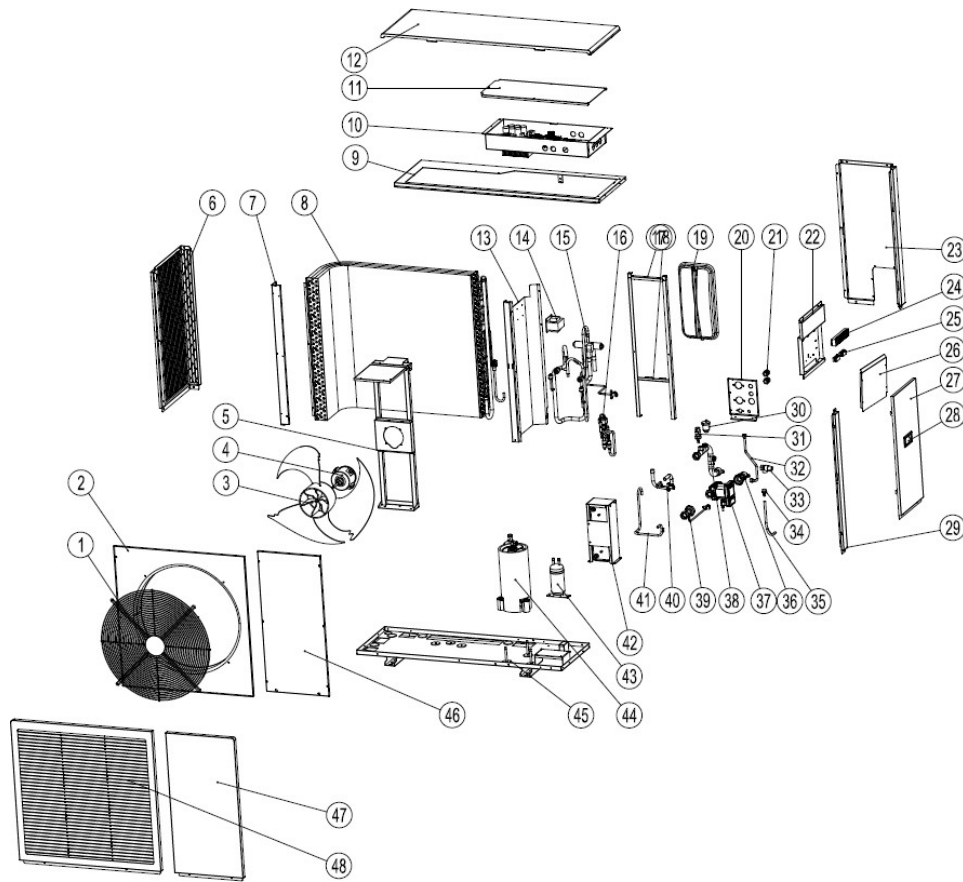

No.	Name	No.	Name	No.	Name
1	Air Cover	17	EEV Support	33	Safe Valve
2	Air Guide	18	Expansion Tank Plate	34	Safe Valve Connector
3	Fan Blade	19	Expansion Tank	35	Drain Hose
4	Fan	20	Valve Block Panel	36	Water Pump Inlet Pipe
5	Fan Support	21	Waterproof Connector	37	Inverter Water Pump
6	Left Side Panel	22	Terminal Block Panel	38	Plate Heat Exchanger Outlet Pipe (Water Side)
7	Left Column	23	Rear Right-Side Panel	39	Plate Heat Exchanger Inlet Pipe (Water Side)
8	Evaporator	24	Terminal Block	40	Plate Heat Exchanger Inlet Pipe (Refrigerant Side)
9	Top Frame	25	Wire Crimp	41	Plate Heat Exchanger Outlet Pipe (Refrigerant Side)
10	Electric Box	26	Wiring Box Cover	42	Plate Heat Exchange
11	Electrical Box Cover	27	Right Side Panel	43	Reservoir (not built-in)
12	Top Cover	28	Handle	44	Compressor
13	Middle Panel	29	Right Front Column	45	Chassis Assembly
14	Reactor	30	Water Flow Switch	46	Right Panel
15	4-Way Valve Assembly	31	Automatic Air Vent	47	Front Right Panel
16	EEV Assembly	32	Expansion Tank Pipe	48	Front Left Panel

## Exploded View

### HPRP18HT

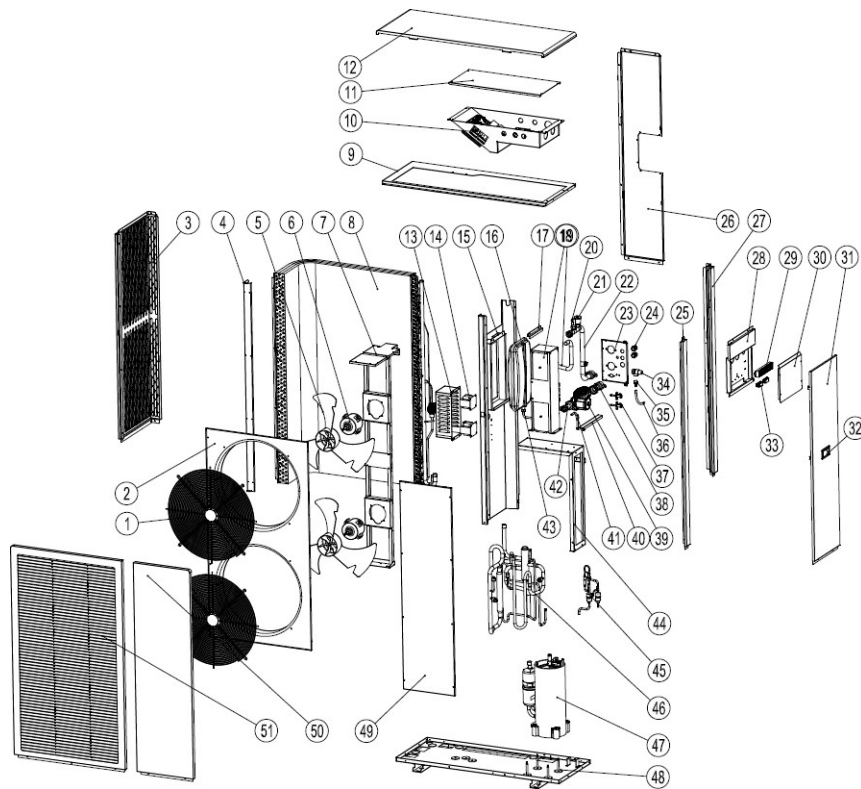

No.	Name	No.	Name	No.	Name	No.	Name
1	Air Cover	14	Reactor	27	Rear Right	40	Water Pump Support
2	Air Guide	15	Middle Panel	28	Terminal Block Panel	41	Plate Heat Exchanger Outlet Pipe (Refrigerant Side)
3	Left Side Panel	16	Expansion Tank	29	Terminal Block	42	Plate Heat Exchanger Inlet Pipe (Water Side)
4	Left Column	17	Expansion Tank Panel	30	Wiring Box Cover	43	Expansion Tank Hose
5	Fan Blade	18	Plate Heat Exchanger	31	Right Side Panel	44	Plate Heat Exchanger Support
6	Fan	19	Plate Heat Exchanger Inlet Pipe (Refrigerant Side)	32	Handle	45	EEV Assemble
7	Fan Support	20	Water Flow Switch	33	Wire Crimp	46	4-Way Valve Assembly
8	Evaporator	21	Automatic Air Vent	34	Safe Valve	47	Compressor
9	Top Frame	22	Plate Heat Exchanger Outlet Pipe (Water Side)	35	Safe Valve Connector	48	Chassis Assembly
10	Electric Box	23	Valve Block Panel	36	Drain Hose	49	Right Panel
11	Electrical Box Cover	24	Waterproof Connector	37	Maintenance Valve	50	Front Right Panel
12	Top Cover	25	Front Right Column	38	Water Pump Inlet Pipe	51	Front Left Panel
13	Reactor Cover	26	Rear Right Side Panel	39	Inverter Water Pump		



## HPRP12HT

Heating Capacity												
Ambient Temp. (°C)	Water Outlet Temperature(°C)											
	25			35			45			55		
	Heating Capacity (kW)	Power Input (kW)	COP	Heating Capacity (kW)	Power Input (kW)	COP	Heating Capacity (kW)	Power Input (kW)	COP	Heating Capacity (kW)	Power Input (kW)	COP
-25	5.08	1.65	3.08	5.11	2.10	2.44	5.13	2.67	1.92	5.16	3.24	1.59
-20	5.84	1.75	3.35	5.87	2.22	2.64	5.90	2.83	2.09	5.94	3.44	1.73
-15	6.71	1.85	3.63	6.75	2.36	2.87	6.79	3.00	2.26	6.83	3.64	1.88
-10	7.72	1.96	3.94	7.76	2.50	3.11	7.81	3.18	2.46	7.85	3.86	2.03
-7	8.88	2.08	4.27	8.93	2.65	3.37	8.98	3.37	2.67	9.03	4.09	2.21
-2	10.21	2.18	4.68	10.27	2.78	3.70	10.33	3.54	2.92	10.39	4.30	2.42
2	10.41	2.14	4.87	10.47	2.72	3.85	10.53	3.47	3.04	10.59	4.21	2.52
7	11.98	2.05	5.83	12.05	2.61	4.61	12.11	3.33	3.64	12.18	4.04	3.01
12	13.17	1.93	6.83	13.25	2.46	5.39	13.32	3.13	4.26	13.40	3.80	3.53
20	13.70	1.74	7.89	13.78	2.21	6.23	13.86	2.82	4.92	13.94	3.42	4.08
27	14.25	1.56	9.12	14.33	1.99	7.20	14.41	2.53	5.69	14.49	3.08	4.71

1.Test Standard : EN14511

Notes: Peak heating capacity values do not take account of capacity drops caused by frost and during defrosting.

Heating Capacity												
Ambient Temp. (°C)	Water Outlet Temperature(°C)											
	60			65			70			75		
	Heating Capacity (kW)	Power Input (kW)	COP	Heating Capacity (kW)	Power Input (kW)	COP	Heating Capacity (kW)	Power Input (kW)	COP	Heating Capacity (kW)	Power Input (kW)	COP
-25	4.98	3.50	1.43	4.80	3.75	1.28	/	/	/	/	/	/
-20	5.73	3.71	1.55	5.52	3.97	1.39	/	/	/	/	/	/
-15	6.59	3.93	1.68	6.35	4.21	1.51	6.11	4.50	1.36	5.87	4.78	1.23
-10	7.58	4.16	1.82	7.30	4.47	1.63	7.02	4.77	1.47	6.75	5.07	1.33
-7	8.71	4.41	1.97	8.39	4.73	1.77	8.08	5.05	1.60	7.76	5.38	1.44
-2	10.02	4.63	2.16	9.65	4.97	1.94	9.29	5.31	1.75	8.92	5.64	1.58
2	10.22	4.54	2.25	9.85	4.87	2.02	9.47	5.20	1.82	9.10	5.53	1.65
7	11.75	4.36	2.70	11.32	4.68	2.42	10.89	4.99	2.18	10.47	5.31	1.97
12	12.93	4.10	3.16	12.46	4.40	2.83	11.98	4.69	2.55	11.51	4.99	2.31
20	13.45	3.69	3.65	12.95	3.96	3.27	12.46	4.22	2.95	11.97	4.49	2.66
27	13.98	3.32	4.21	13.47	3.56	3.78	12.96	3.80	3.41	12.45	4.04	3.08

1.Test Standard : EN14511

Notes: Peak heating capacity values do not take account of capacity drops caused by frost and during defrosting.

Cooling Capacity <sup>1</sup>									
Ambient Temperature(°C)	Water Outlet Temperature(°C)								
	7			12			18		
	Cooling Capacity(kW)	Power Input(kW)	EER	Cooling Capacity(kW)	Power Input(kW)	EER	Cooling Capacity(kW)	Power Input(kW)	EER
15	10.00	2.09	4.79	11.22	2.14	5.24	12.67	2.21	5.74
20	9.53	2.32	4.11	10.68	2.38	4.49	12.07	2.45	4.92
25	9.07	2.58	3.52	10.18	2.64	3.85	11.50	2.72	4.22
30	8.64	2.87	3.02	9.69	2.94	3.30	10.95	3.03	3.62
35	8.23	3.18	2.59	9.23	3.27	2.83	10.43	3.36	3.10
40	7.84	3.54	2.22	8.79	3.63	2.42	9.93	3.74	2.66
45	7.47	3.93	1.90	8.37	4.03	2.08	9.46	4.15	2.28

1.Test Standard : EN14511

## HPRP18HT

Heating Capacity <sup>1</sup>												
Ambient Temp. (°C)	Water Outlet Temperature(°C)											
	25			35			45			55		
	Heating Capacity (kW)	Power Input (kW)	COP	Heating Capacity (kW)	Power Input (kW)	COP	Heating Capacity (kW)	Power Input (kW)	COP	Heating Capacity (kW)	Power Input (kW)	COP
-25	7.64	2.67	2.86	7.63	3.28	2.32	7.63	4.03	1.89	7.63	4.78	1.60
-20	8.78	2.83	3.10	8.78	3.48	2.52	8.78	4.28	2.05	8.77	5.07	1.73
-15	10.10	3.01	3.36	10.10	3.69	2.74	10.09	4.53	2.23	10.09	5.37	1.88
-10	11.61	3.19	3.65	11.61	3.91	2.97	11.61	4.80	2.42	11.60	5.70	2.04
-7	13.36	3.38	3.96	13.35	4.15	3.22	13.35	5.09	2.62	13.34	6.04	2.21
-2	15.36	3.55	4.33	15.35	4.35	3.53	15.35	5.35	2.87	15.34	6.34	2.42
2	15.67	3.47	4.51	15.66	4.27	3.67	15.66	5.24	2.99	15.65	6.21	2.52
7	18.02	3.34	5.40	18.01	4.10	4.40	18.00	5.03	3.58	18.00	5.96	3.02
12	19.82	3.14	6.32	19.81	3.85	5.15	19.80	4.73	4.19	19.80	5.61	3.53
20	20.61	2.82	7.30	20.60	3.47	5.95	20.60	4.26	4.84	20.59	5.05	4.08
27	21.44	2.54	8.44	21.43	3.12	6.87	21.42	3.83	5.59	21.41	4.54	4.72

1.Test Standard : EN14511

Notes: Peak heating capacity values do not take account of capacity drops caused by frost and during defrosting.

Heating Capacity <sup>1</sup>												
Ambient Temp. (°C)	Water Outlet Temperature(°C)											
	60			65			70			75		
	Heating Capacity (kW)	Power Input (kW)	COP	Heating Capacity (kW)	Power Input (kW)	COP	Heating Capacity (kW)	Power Input (kW)	COP	Heating Capacity (kW)	Power Input (kW)	COP
-25	7.34	5.18	1.42	7.06	5.58	1.27	/	/	/	/	/	/
-20	8.45	5.49	1.54	8.12	5.91	1.37	/	/	/	/	/	/
-15	9.71	5.82	1.67	9.34	6.27	1.49	8.96	6.72	1.33	8.58	7.16	1.20
-10	11.17	6.17	1.81	10.74	6.64	1.62	10.30	7.12	1.45	9.87	7.59	1.30
-7	12.84	6.54	1.96	12.35	7.04	1.75	11.85	7.55	1.57	11.35	8.05	1.41
-2	14.77	6.87	2.15	14.20	7.40	1.92	13.63	7.92	1.72	13.06	8.45	1.54
2	15.07	6.73	2.24	14.48	7.25	2.00	13.90	7.77	1.79	13.32	8.28	1.61
7	17.33	6.46	2.68	16.66	6.96	2.39	15.98	7.46	2.14	15.31	7.95	1.93
12	19.06	6.07	3.14	18.32	6.54	2.80	17.58	7.01	2.51	16.85	7.47	2.25
20	19.82	5.47	3.63	19.05	5.89	3.24	18.29	6.31	2.90	17.52	6.73	2.60
27	20.61	4.92	4.19	19.82	5.30	3.74	19.02	5.68	3.35	18.22	6.05	3.01

1.Test Standard : EN14511

Notes: Peak heating capacity values do not take account of capacity drops caused by frost and during defrosting.

Cooling Capacity <sup>1</sup>									
Ambient Temperature(°C)	Water Outlet Temperature(°C)								
	7			12			18		
	Cooling Capacity(kW)	Power Input(kW)	EER	Cooling Capacity(kW)	Power Input(kW)	EER	Cooling Capacity(kW)	Power Input(kW)	EER
15	17.40	3.85	4.52	19.37	3.78	5.13	21.74	3.69	5.89
20	16.57	4.27	3.88	18.45	4.20	4.40	20.71	4.10	5.05
25	15.78	4.75	3.32	17.57	4.66	3.77	19.72	4.56	4.32
30	15.03	5.28	2.85	16.74	5.18	3.23	18.78	5.07	3.71
35	14.32	5.86	2.44	15.94	5.76	2.77	17.89	5.63	3.18
40	13.63	6.51	2.09	15.18	6.40	2.37	17.04	6.26	2.72
45	12.99	7.24	1.79	14.46	7.11	2.03	16.22	6.95	2.33

1.Test Standard : EN14511

# Water Pump Performance HPRP12HT

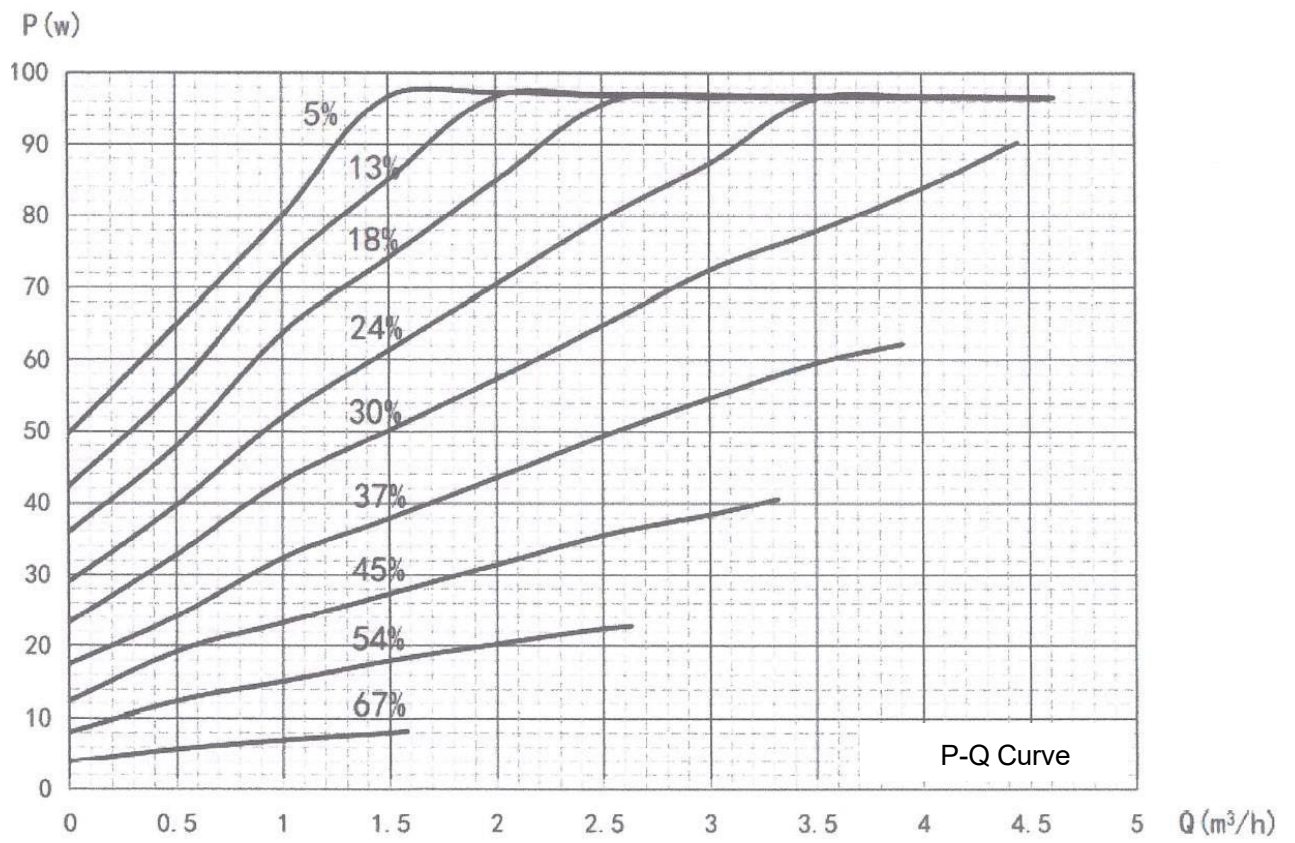
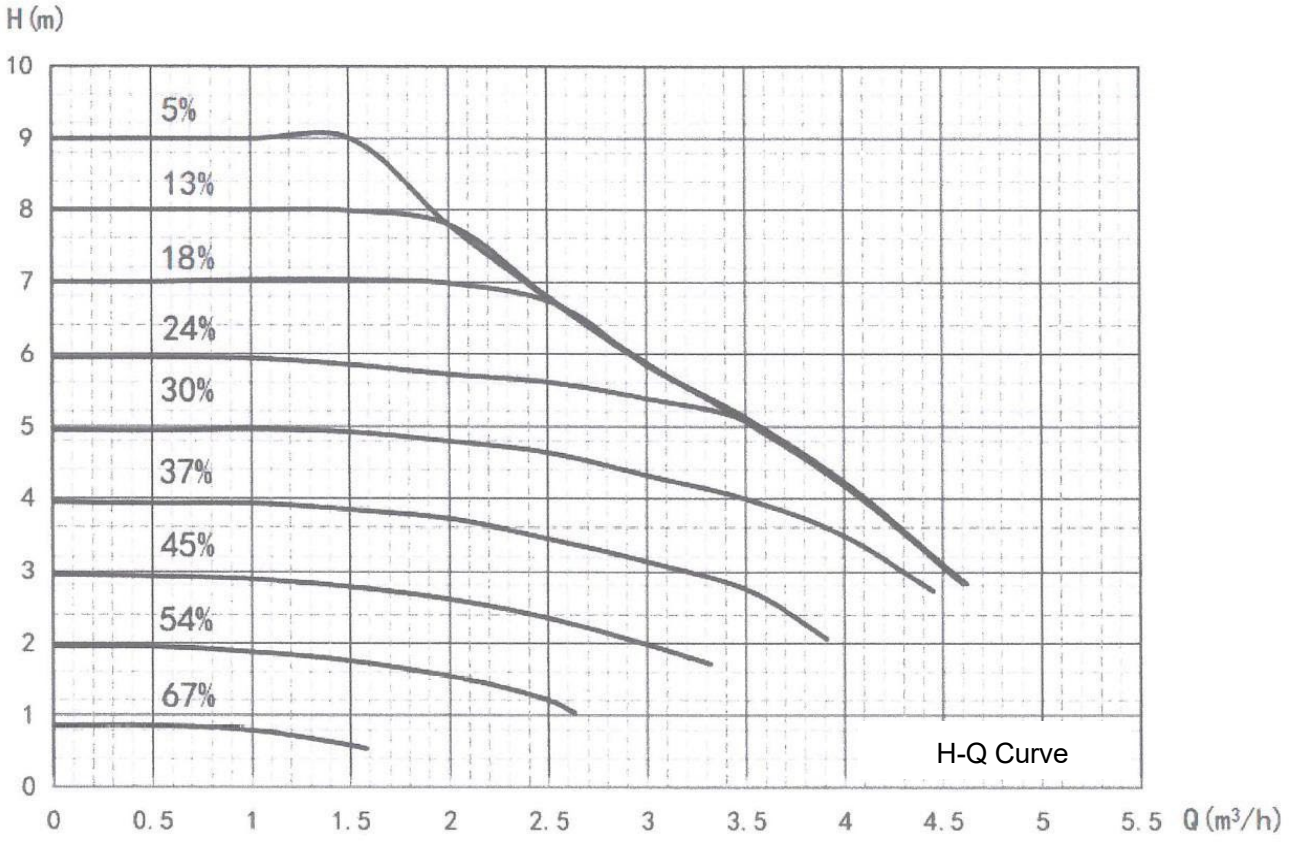



# Water Pump Performance

## HPRP18HT

H (m)

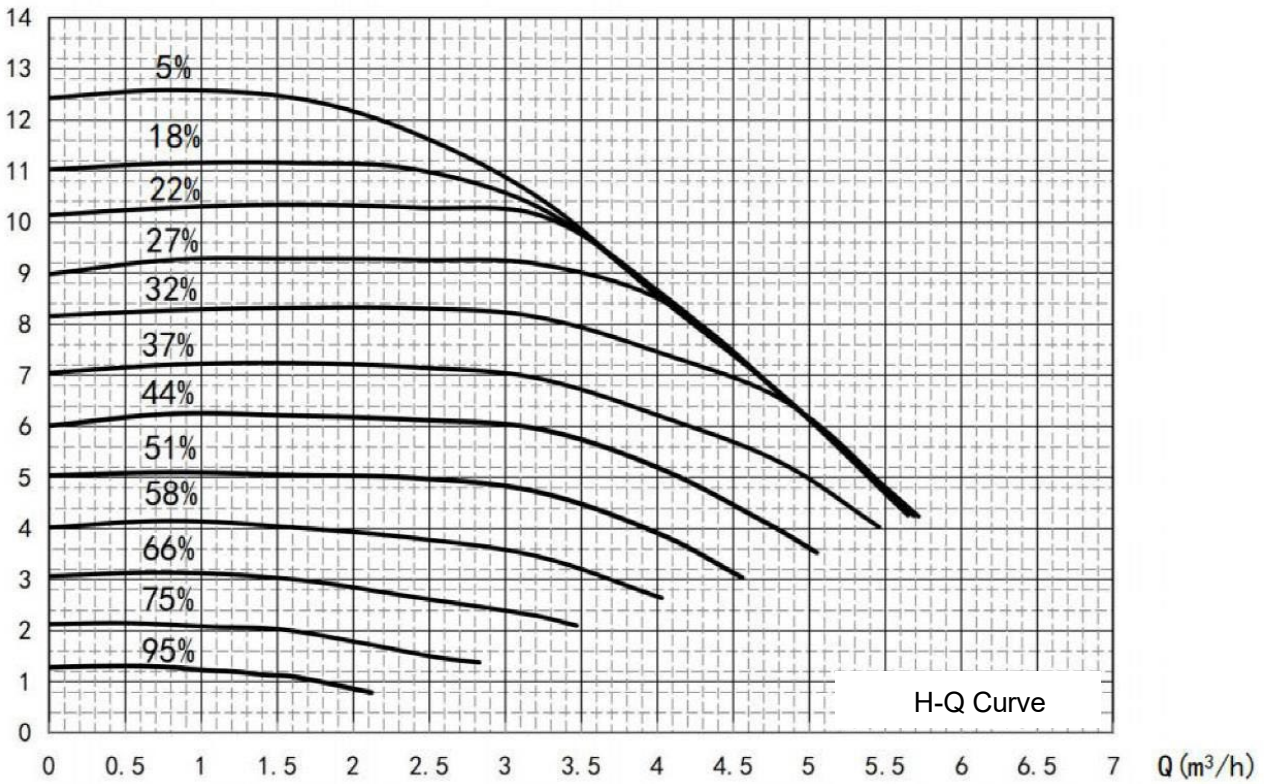

P (w)

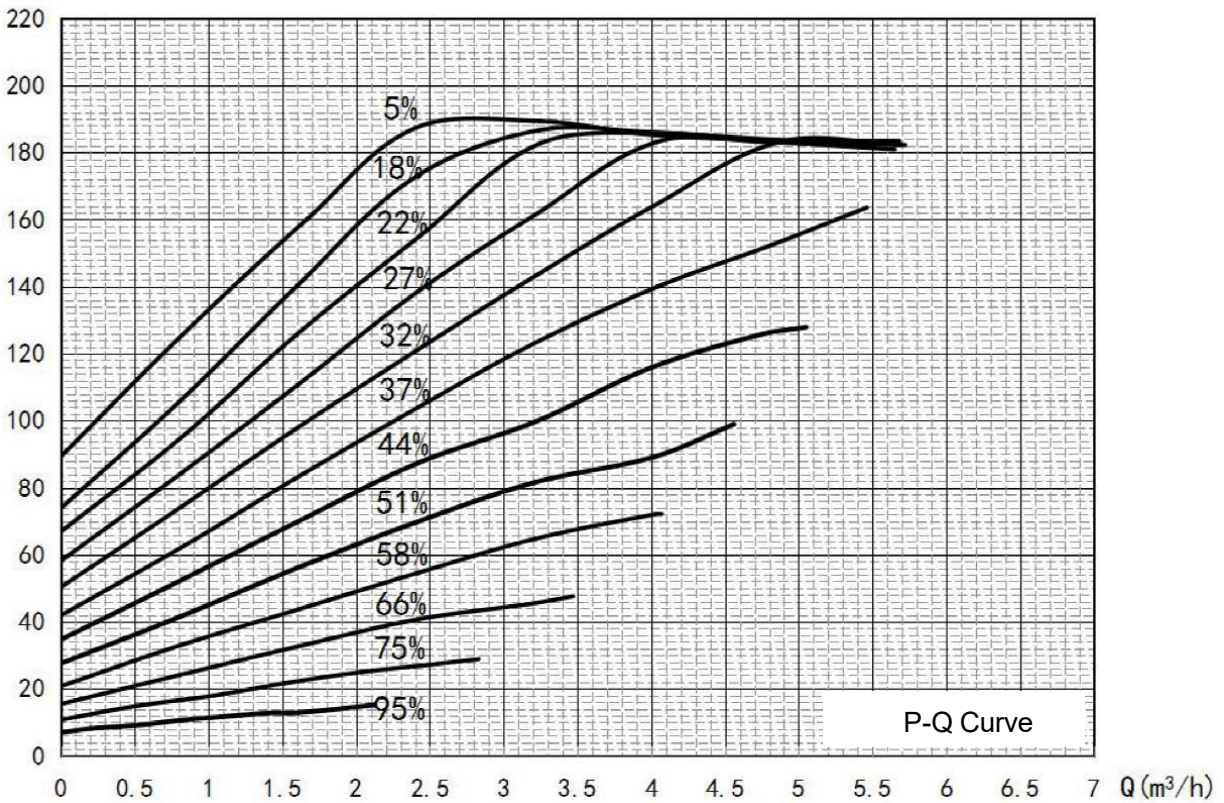



## Built-in Temperature Sensors

Built-in temperature sensor needs to be enabled by dip switch or parameter.

No.	Sensor Type	Color/Spec.	Setting	Refer to	Note
T9	Total Water Outlet Temp.	Black/5K	DIP Switch	Page 13	Disable (Default)
T10	Buffer Tank Temp.	Green/5K	DIP Switch	Page 13	Disable by default
T16	DHW Tank Temp.	Blue/5K	P48	Page 13	Disable by default

## DIP Switch Definitions

DIP Switch Type	Functions	Status
SW1	Setting the Master and Slave Addresses	
SW2	Setting Unit Functions	

## SW1 Definitions

Address setting combinations for master and slave:

No.	SE1	SE2	SE3	SE4	Status
Master	OFF	OFF	OFF	OFF	
Slave1	ON	OFF	OFF	OFF	
Slave2	OFF	ON	OFF	OFF	

## Single Installation Requirements

Installation space:

Unit: mm

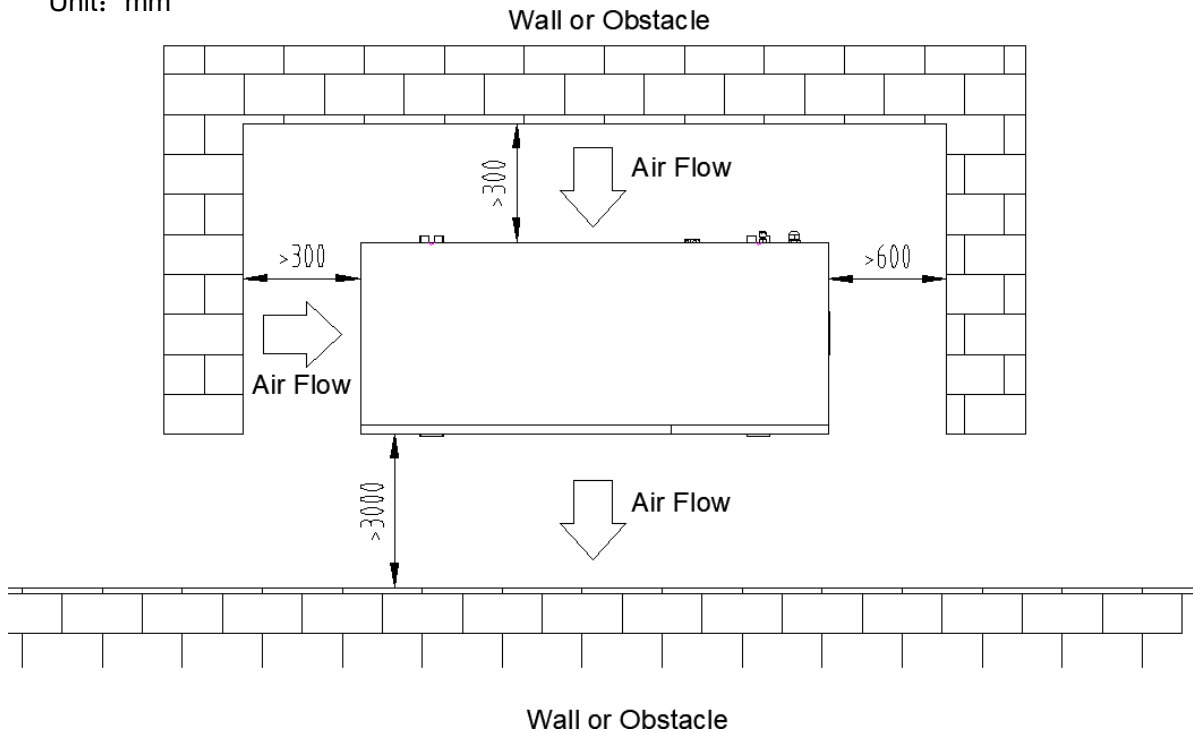

## Cascade Installation Requirements

The unit shall be installed in a place with air circulation, no heat radiation or other heat sources, and the allowable minimum distance between the unit and the surrounding walls or other shelters is:

Installation Type 1: the distance between the air inlet surface and the wall is more than 300mm, the distance between every 2 units is more than 600mm, as shown in the figure:

Unit: mm

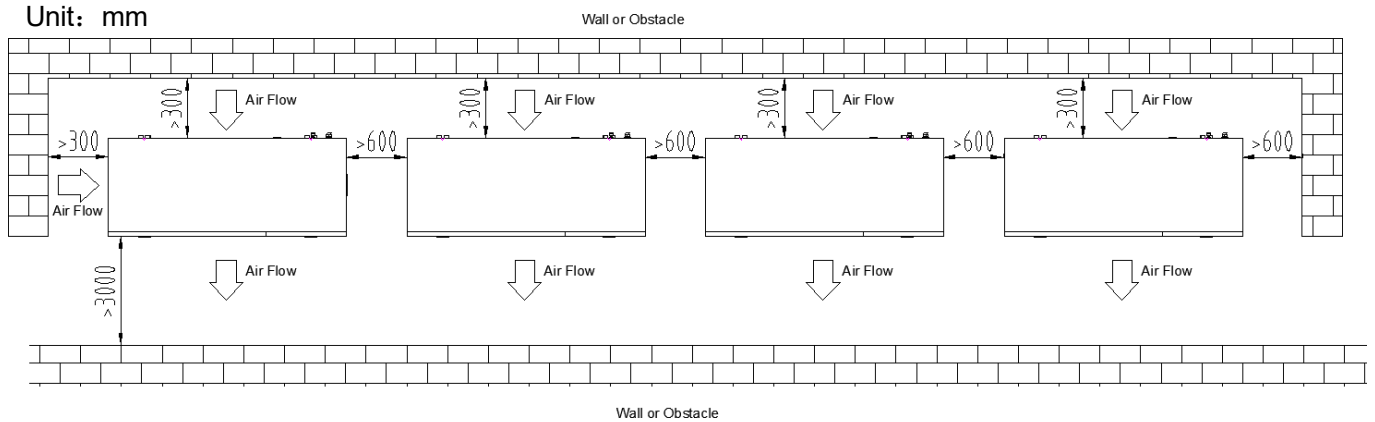

Installation Type 2: the distance between the air inlet surface and the wall is more than 4000mm, the distance between every 2 units is more than 4000mm, as shown in the figure:

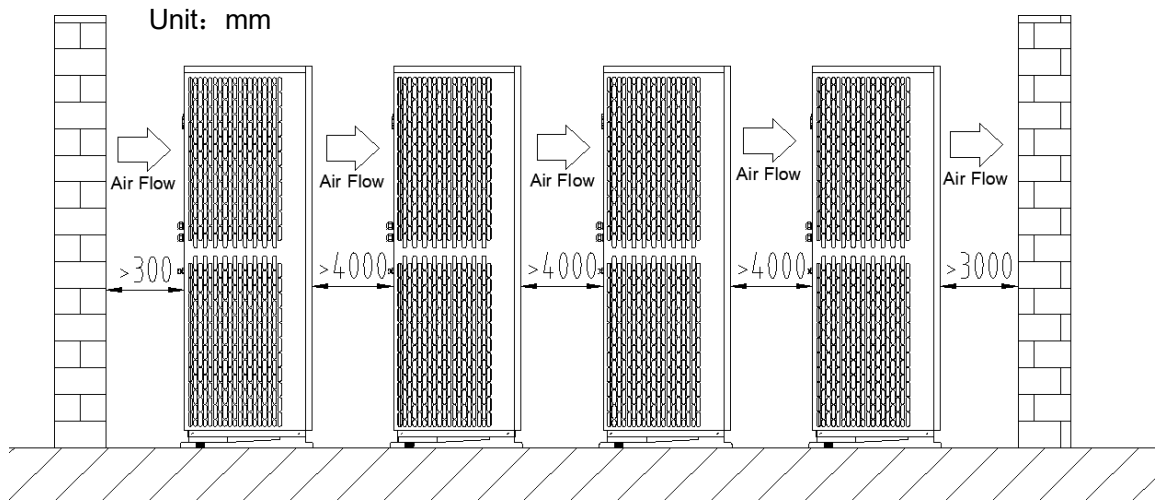

Installation Type 3: the distance between the air inlet surface and the air inlet surface is more than 300mm, the distance between every 2 units is more than 4000mm, as shown in the figure:

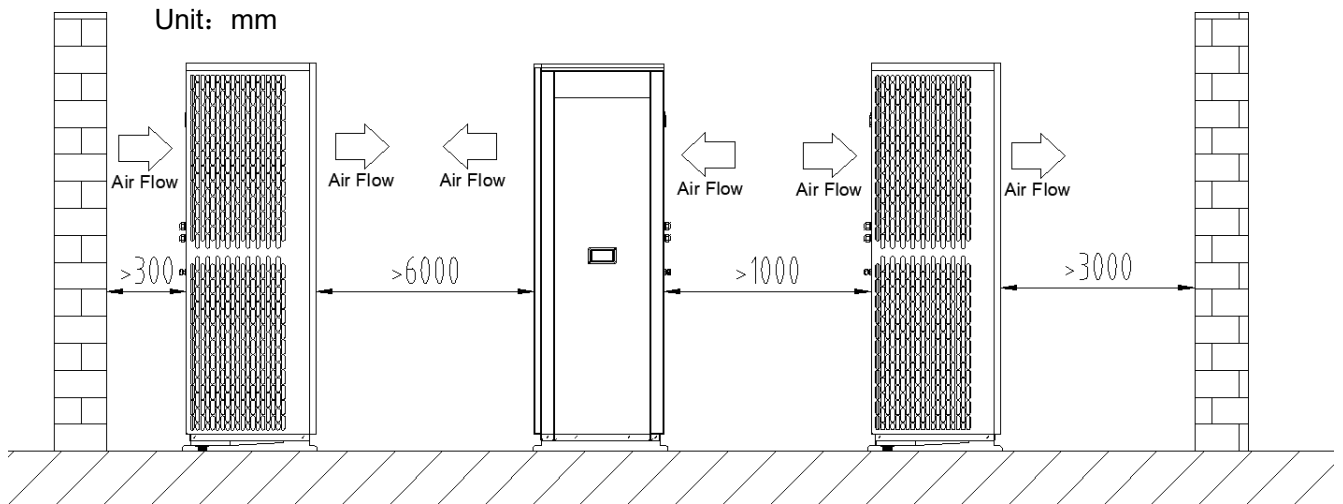

### Cold Climate Installation

In snowy areas, anti-snow facilities shall be installed. In order not to be affected by snow, an elevated platform is adopted, and an anti-snow shed is installed at the air inlet and air outlet.



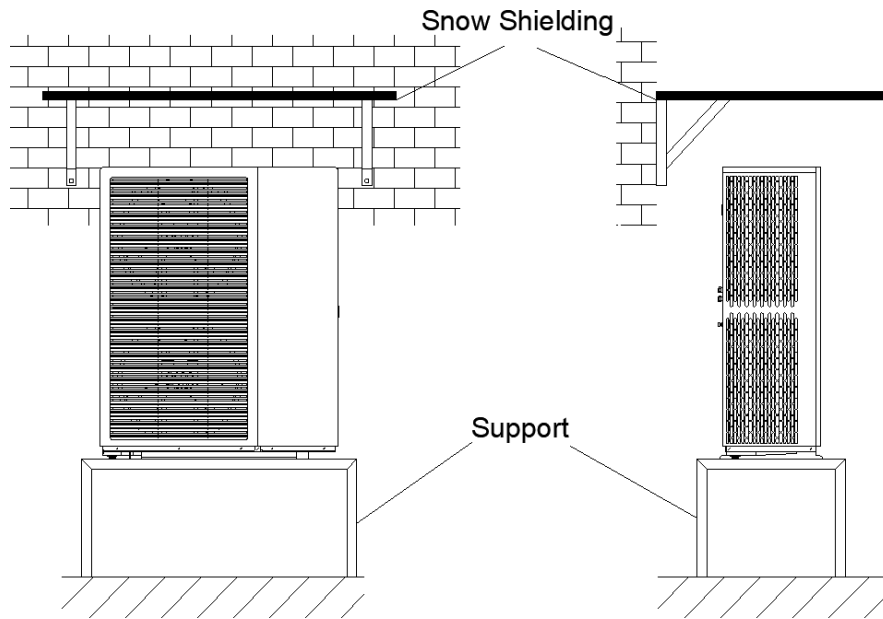

### Hot Climate Installation

As the outdoor temperature is measured via the outdoor ambient temperature sensor, make sure to install the unit in the shade, or a canopy should be constructed to avoid direct sunlight. So that it is not influenced by the sun's heat, otherwise system protection may occur.

### Base Mounting Requirements

Outdoor unit base structure design should take account of the following considerations:

- A solid base prevents excess vibration and noise. Outdoor unit bases should be constructed on solid ground or on structures of sufficient strength to support the unit's weight.
- Base should be at least 100mm high to provide sufficient drainage and to prevent water ingress into the base of the unit.
- Either steel or concrete bases may be suitable.
- Outdoor units should not be installed on supporting structures that could be damaged by water built-in in the event of a blocked drain.
- Fix the unit securely to foundation by means of the  $\Phi 10$  expansion bolt. It is best to screw in the foundation bolts until their length is 20mm from the foundation surface.

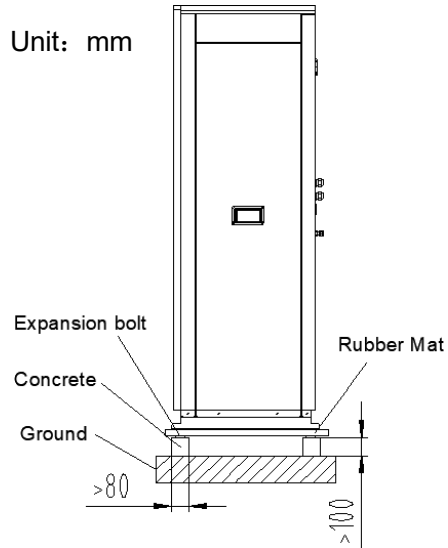

### Drainage Pipe Installation Requirements

The unit's drain holes are designed for uniform drainage treatment, and condensate will be generated when the unit is running in heating mode or hot water mode. Therefore, when installing the unit, make sure that there is enough space in the drain hole for condensate to be discharged.

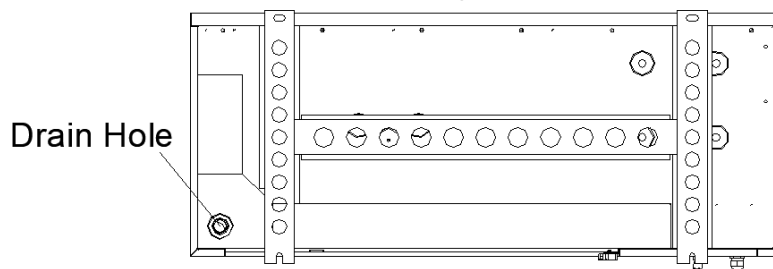

Unit: mm

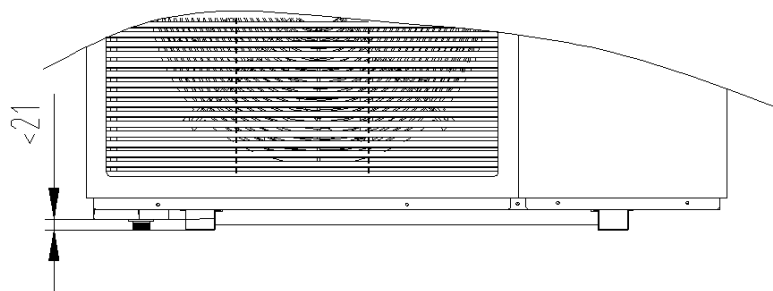

When installing the drain spout, pay attention to the distance of the chassis from the footing

## Water System Installation Refill Requirements

- Open the vent valve on the distributor first, as well as all the valves.
- Refill water at the piping refill port.
- In the process of water refilling, it is necessary to observe whether there is water overflow from the exhaust valve, if there is water overflow, it means that the water in the system has been filled.
- Close the exhaust valve, and then observe the water pressure gauge. If it is greater than 0.15Mpa, you can close the refill valve, the waterway air evacuation is complete.

## Water Pipe Insulation Requirements

- All hot water pipes must be wrapped with insulation.
- Wrap the insulation material (e.g., thin aluminum sheet, aluminum foil, etc.) flatly on the pipe that has been wrapped with insulation pipe and wrap the tie.
- The thickness of the insulation pipe should be reasonably selected according to the local climate, DN20 pipe using more than 10mm thickness of insulation cotton; finally wrapping a layer of wrapping tape on the insulation cotton.

## Water Pipe Freeze Protection Requirements

Freezing can cause damage to the circulation system. Care must be taken to prevent the system from freezing as the outdoor unit will be exposed to sub-zero temperatures. All internal fluid circulation components need to be insulated to minimize heat loss. Piping must also be insulated with additional insulation.

In the event of a power failure, the unit's freeze protection will fail. Due to the possibility of power failures when unattended, suppliers recommend the use of antifreeze in the water system.

Depending on the expected minimum outdoor temperature, ensure that the water system is injected with the glycol concentration shown in the table below. The performance of the unit will be affected when glycol is added to the system. Correction factors for system unit capacity, flow rate, and pressure drop are listed in the table.

Glycol Concentration (%)	Correction Factor				Freezing Point (°C)
	Cooling Capacity	Power input	Water Resistance	Water Flow	
0	1.000	1.000	1.000	1.000	0
10	0.984	0.998	1.118	1.019	-4
20	0.973	0.995	1.268	1.051	-9
30	0.965	0.992	1.482	1.092	-16

Propylene Glycol Concentration (%)	Correction Factor				Freezing Point (°C)
	Cooling Capacity	Power input	Water Resistance	Water Flow	
0	1.000	1.000	1.000	1.000	0
10	0.976	0.996	1.071	1.000	-3
20	0.961	0.992	1.189	1.016	-7
30	0.948	0.988	1.380	1.034	-13

Uninhibited glycol becomes acidic under the influence of oxygen. Copper purity and higher temperatures accelerate this process. Acidic uninhibited glycol will eat away at metal surfaces, forming galvanic corrosion cells that can cause serious damage to the system.

This is extremely important:

- Water treatment is properly performed by a water specialist who should be qualified.
- Glycols containing corrosion inhibitors are selected to counteract the acids formed by the oxidation of the glycol.
- IF domestic hot water tank is installed, only propylene glycol is permitted. In other installations, the use of ethylene glycol is permitted.
- Automotive glycols are not used because they have a limited corrosion inhibitor life and contain silicates that can contaminate or clog the system.
- Galvanized piping is not used in glycol systems because it can cause precipitation of certain elements in glycol corrosion inhibitors.
- Ensure that the glycol is compatible with the materials used in the system.

## Electrical wiring

### Precautions

- Special outdoor power supply line should be used, and the power supply voltage meets the rated voltage requirement.
- The power supply line of the unit must have a grounding line, and the power supply ground line should be reliably connected with the external grounding line, and the external grounding is effective.
- The user's incoming power supply must be installed with leakage protection device.
- The wiring construction must be connected by professional installation technician according to the circuit diagram.
- The power supply cable and signal cable should be neatly and reasonably arranged, not interfering with each other, not in contact with the connecting pipe and valve body and ensure that the minimum distance between the strong and weak power is more than 25mm.
- The wire controller should be installed in the place where it is easy to observe the operation and should not be installed in the place where there is water and humidity.
- The connection lines in the host have been installed in the factory, the user does not need to connect again, but only need to check whether the connection lines are connected properly, there is no damage or fall off.
- The wire connecting the temperature probe and controller is not long enough to be properly lengthened and connected, with a total length of not more than 20 meters. Note that the connection should be firmly wrapped and waterproof insulation.
- High-voltage side cable: unit power lines, pump power lines, electric heating power lines, solenoid valve power lines, etc. need to use anti-aging, corrosion-resistant power lines suitable for outdoor (H07RN-F type or higher).



**IMPORTANT NOTE: Always ensure that the heat pump power supply is disconnected before carrying out any electrical installation work.**

### Power Supply Cable Selection

To function safely and maintain the integrity of your electrical system, the unit must be connected to a general electricity supply under the following regulations:

- Upstream, the general electricity supply must be protected by a 30mA differential switch.
- The heat pump must be connected to a suitable D-curve circuit breaker in accordance with current standards and regulations in the country where the system is installed.
- The electricity supply cable must be adapted to match the unit's rated power and the length of wiring required by the installation. The cable must be suitable for outdoor use.
- For a three-phase system, it is essential to connect the phases in the correct sequence. If the phases are inverted, the heat pump's compressor will not work.
- In places open to the public, it is mandatory to install an emergency stop button close to the heat pump.

Model	Power Supply Wires		
	Power Supply	Cable Diameter	Specification
HPRP12HT	220-240V~/ 50Hz	3G 4mm <sup>2</sup>	AWG 12
HPRP18HT		3G 6mm <sup>2</sup>	AWG 10

### Power Cord Outlet Guidelines

Secure the electrical wiring with cable ties. So that it does not meet the piping.

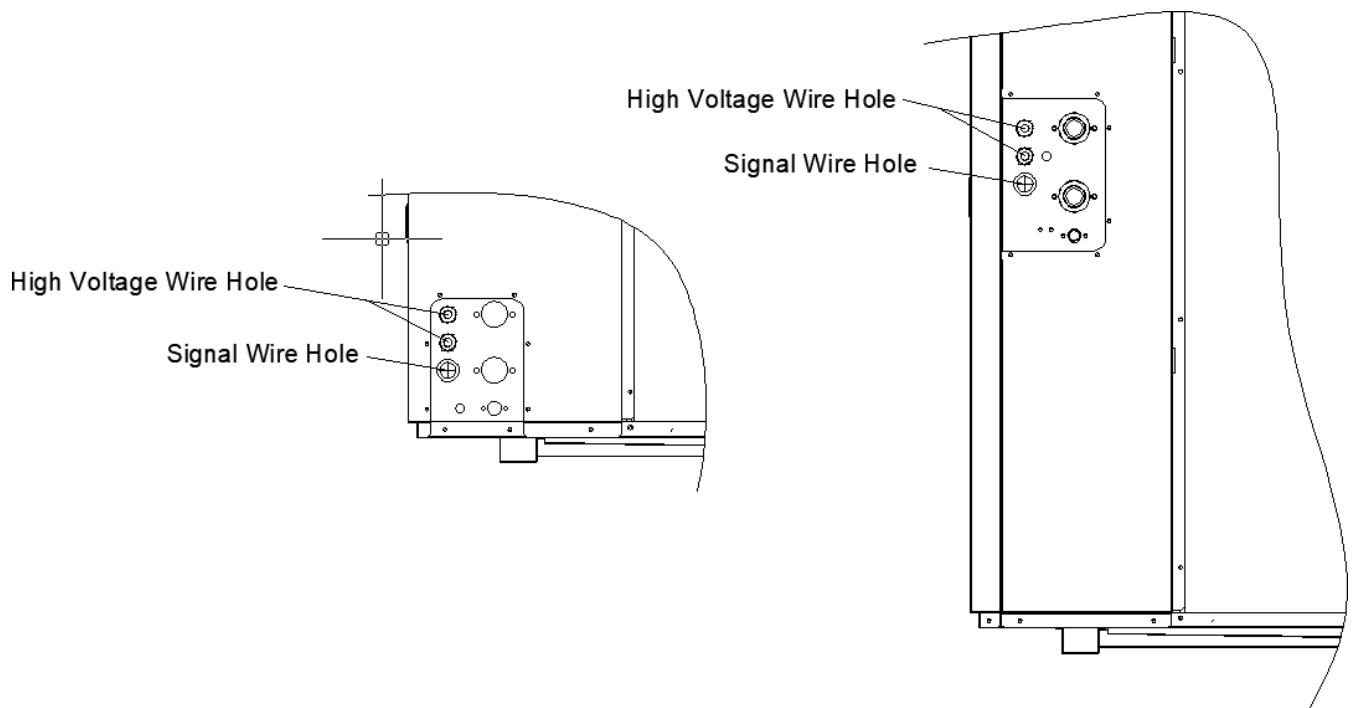

## Terminal Block Port Introduction

### HPRP12HT/HPRP18HT

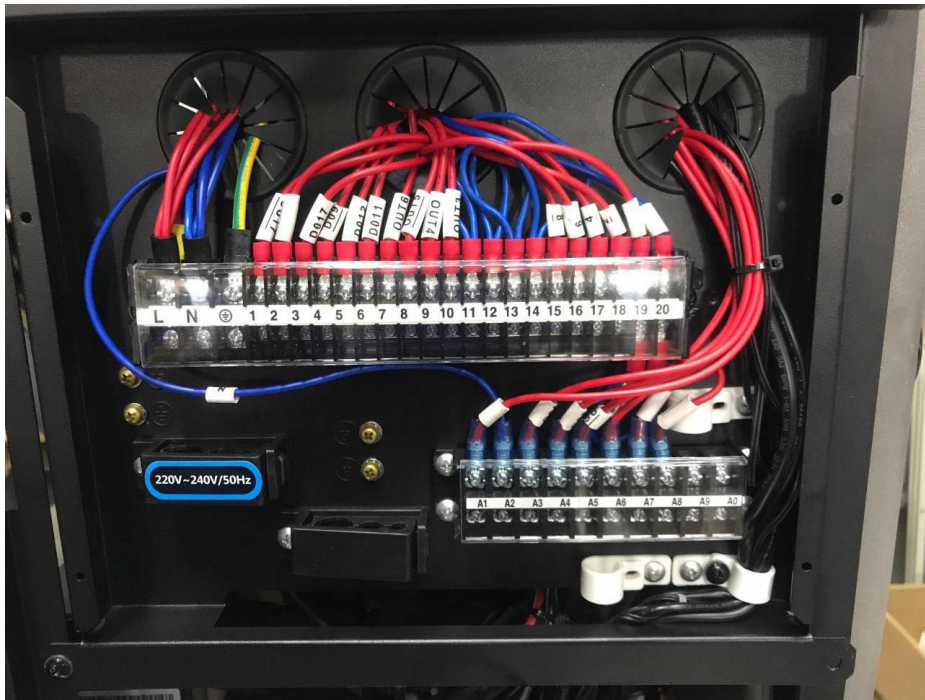

Print	Connect to	Print	Connect to
L	Power Input (220V-240V~/50Hz)	15-20	Forced Cooling Switch
N	Null Line	16-20	Linkage Switch (External Water Pump)
⊕	PE	17-20	Forced Heating Switch
1-N	EH1# Electric Heater (DHW)	18-20	Linkage Switch (Heat Source of DHW)
2-N	P_b# Heating/Cooling Water Pump	19-20	Linkage Switch
3-N	P_c# Auxiliary Water Pump	20	COM
4-N	EH2# Electric Heater (Buffer Tank)	A1-A2	P_h# Mixing Water Pump
5-N	P_d# DHW Return Water Pump	A2	Null Line
6-N	P_e# AHS Water Pump	A3-N	SV3# Mixing Valve (Close)
7-N	SV1# 3-Way Valve (to Buffer Tank)	A4-N	SV3# Mixing Valve (Open)
8-N	SV1# 3-Way Valve (to DHW)	A5-A6	SG Signal
9-N	SV2# 3-Way Valve (to Cooling)	A6	COM
10-N	SV2# 3-Way Valve (to Heating)	A7-A8	EVU Signal
11	Null Line	A8	COM
12	Null Line	A9	Reserve
13	Null Line	A0	Reserve
14	Null Line		

### Electric Heater/AHS

Electric heater requires additional relays, please refer to wiring diagram:

No.	Wring Type	Output Type
EH1/AHS		Type 1
* If AHS is used for buffer tank, connect to EH1		

### Water Pump

Water pump requires additional relays, please refer to wiring diagram:

No.	Wring Type	Output Type
P_b <sup>1</sup> Heating/Cooling Water Pump		Type 1
*1. Water pump can be PWM controlled when connected to the <b>COM4</b> port on the motherboard <b>AP3</b>		

### Three-Way Valve

There are two wiring types for 3-way valves, please refer to the wiring diagram:

Control Type	No.	Wring Type	Description	Output Type
Type 1 (Recommend) 	SV1 3-Way Valve		When the unit is running in heating mode, terminal 7# outputs voltage and terminal 8# no output. When the unit is running in hot water mode, terminal 7# no output and terminal 8# outputs voltage.	Type 1

## Linkage Switch

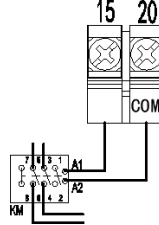
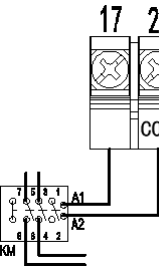
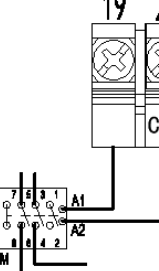
No.	Wring Type	Output Type
Forced Cooling Switch		Type 2
Forced Heating Switch		
Linkage Switch (Room Thermostat)		

## SG Ready

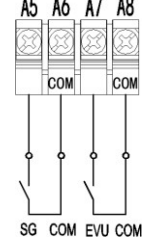
No.	Wring Type	Output Type
SG Ready		Type 2



## Cascade

The wiring of the unit refers to the following way, the dip switch setting refers to **DIP Switch Definitions** (pg.13), and the parameter setting refers to **Cascade** (pg.28).

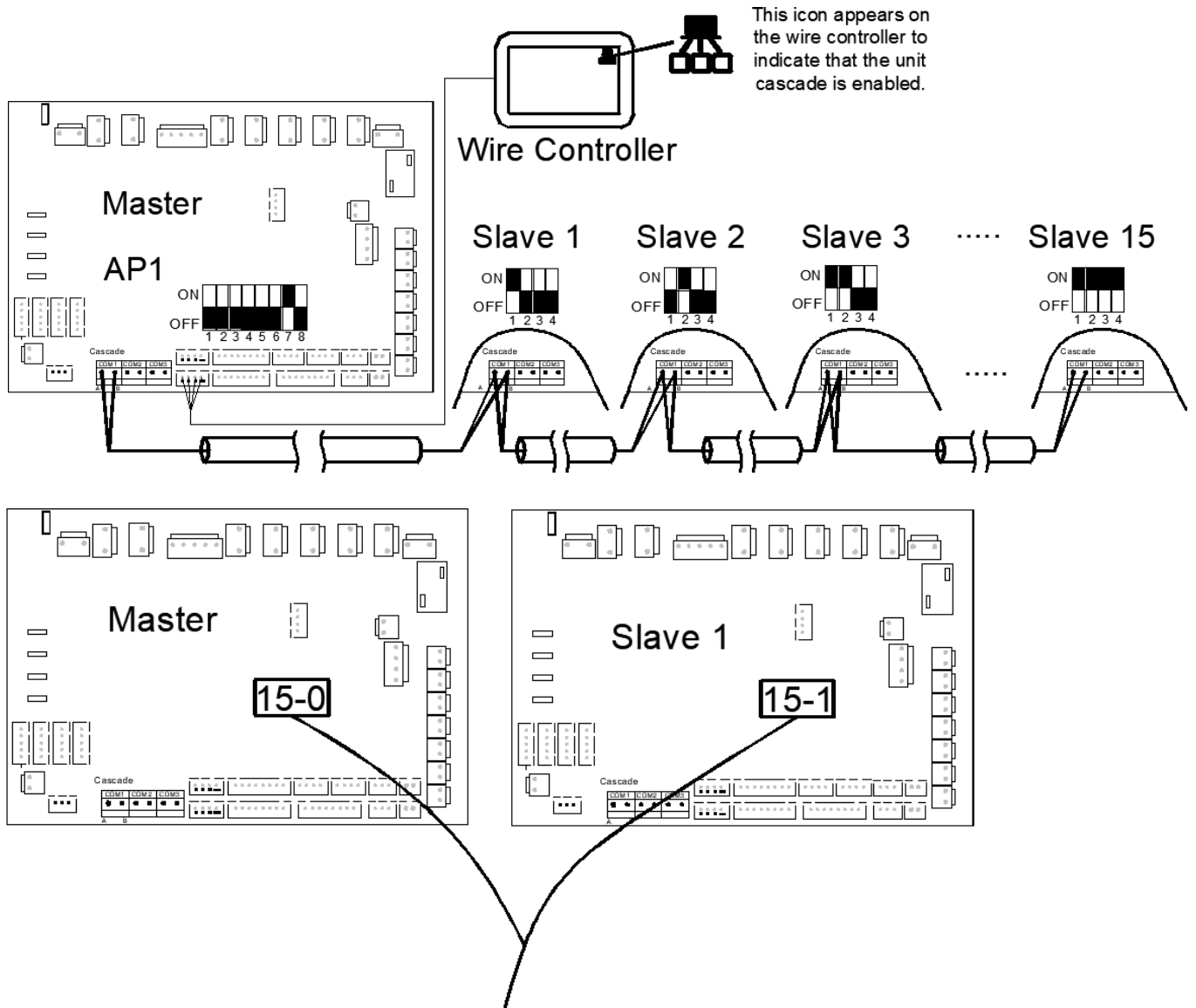

After the units are cascaded, the digital tube on the main board will display the number of cascades and the addresses of the slaves, and you can query the operation of the units with the corresponding addresses on the wire controller.

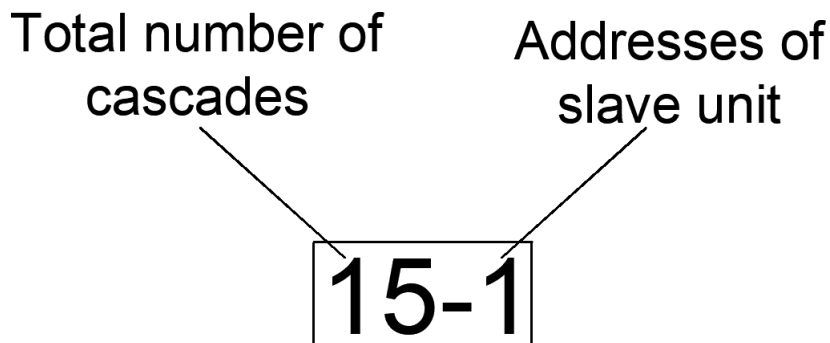

Note:

- With the cascade on, the slave unit is controlled only by the master wire controller.
- Cascade maximum of 1 master unit and 15 slave units.
- Communication cables must be shielded and grounded.

## Unit Operation

This section only introduces the setting parameters and operation introduction of common modes and some parts, for more parameters, please refer to **Parameters and Explanations (pg.45)**.

### Running Mode

It mainly introduces the operation mode and setting parameters of several operation modes of the unit.

### Silent Mode

When running this mode, the unit will reduce the compressor frequency and fan frequency to make the unit less noisy. The maximum compressor frequency and fan frequency will be limited to P88 and P89.

Parameter	Default Value/Range/Unit	Description
P88	50 (20-70) /Hz	Max. compressor operating frequency
P89	40 (20-60) /Hz	Max. fan operating frequency
<p><b>NOTE:</b> Lower frequency leads to lower unit capacity  <b>Example:</b> Turn on the silent mode, the maximum operating frequency of the compressor will be limited to 50Hz, and the maximum operating frequency of the fan will be limited to 40Hz.</p>		

### Electric Heater/AHS

Explanation of the operation and parameters of electric heaters for different locations.

#### Electric Heater of Buffer Tank (EH2) / Electric Heater of DHW Tank (EH1) /AHS

If the tank is installed with electric heater and parameters P139 and P140 are used for electric heater or auxiliary heat source turn on, then the parameters need to be configured as follows, for wiring please refer to **Electrical Wiring (pg.19)**.

Parameter	Setting Value	Description
P139	0	Enable buffer tank electric heater
	1	Disable buffer tank electric heater
	2	Enable auxiliary heat source for heating

## Water Pump

This section explains how each water pump in the system operates.

### Built-in Water Pump (P\_a)

The operation of the unit's built-in circulating water pump is controlled by parameter P28, the settings of which are shown in the table below:

Parameter	Setting Value	Description	Note
P28	0 (Default)	Water pump run continuously after the unit reaches the target temperature	
	1	After the unit reaches the target temperature, water pump runs at a cycle of 2Min every 10Min.	
	2	In cooling mode, the water pump runs continuously after the unit reaches the target temperature.	For cooling mode only, other modes operate as P28=1.
	3	In cooling and heating mode, the water pump runs continuously after the unit reaches the target temperature.	For cooling/heating mode only, other modes are operated according to P28=1.
	4	In heating mode, the pump runs continuously after the floor heating reaches the target water temperature	For underfloor heating water temperature only, other modes operate as P28=1

### Heating/Cooling Water Pump (P\_b)

The water pump is used as a circulating water pump in the heating circuit and the mode of operation is controlled by parameter P150, the settings of which are shown in the table below:

Parameter	Setting Value	Description	Note
P150	1	The water pump starts when the unit is turned on or when it reaches temperature and stops.	
	2	The water pump is controlled via room thermostat	
	3	The water pump is controlled via the wire controller	Wire controller with built-in temperature sensor for use as a room thermostat

### Three-Way Valve

This section explains how the three-way valve operates in the system.

#### SV1#Three-Way Valve

This three-way valve is used to switch between DHW-buffer tank. When switching heating/hot water modes, use the three-way valve to switch the water line, see the following table for specific operation:

Running Mode	Terminal Block No.	Status	Control Type
Hot Water	7#	230V	Type 1
	8#	0V	

### SV3#Three-Way Valve (Mixing Valve)

When the dual zone temperature control is enabled for underfloor heating mixing, see the table below for specific operation:

Three-Way Valve Status	Terminal Block No.	Status	Control Type
Close	A3#	230V	Type 1
	A4#	0V	

### Linkage Switch

The linkage switch is a dry contact signal, indicating both open and closed states.

Terminal Block No.	Description	Operating Principle	Note
15-20	Forced Cooling Switch	When closed, the unit running cooling mode	Open by default, no parameter setting required
16-20	Linkage Switch (External Water Pump)	Used to connect the indoor water pump to link the unit turn ON/OFF	
17-20	Forced Heating Switch	When closed, the unit running heating mode	
18-20	Linkage Switch (Heat Source of DHW)	Usually used to connect solar water heater	
19-20	Linkage Switch	Connect room thermostat, setup parameters refer to <b>Room Thermostat below.</b>	Controlled by parameter P05

### Room Thermostat

Connect the room thermostat and use the room temperature to control the unit on and off.

Parameter	Setting Value	Description
P05	0	Enable the linkage switch, when the linkage switch is opened, the unit will turn off; when the linkage switch is closed, the unit will run according to the water temperature control.
	1	Disable the linkage switch, the unit uses the wire controller to control the units turn ON/OFF
	2	Enable the linkage switch, when the linkage switch is opened, the unit will standby, but the three-way valve and pump will be controlled according to the operation mode set by the unit; when the linkage switch is closed, the unit will be controlled according to the water temperature.
	3	When the linkage switch is enabled, the unit can only be used for heating/cooling.

## Cascade

If more than one unit needs to be installed at the same time, it is necessary to turn on the cascade function for unit control, refer to **SW1 Definitions (p.13)** for the dialing method, and refer to **Electrical Wiring (pg.18)** wiring and installation. For specific parameter settings, please refer to the following table:

Parameter	Setting Value	Description	Note
P164	0	Enable cascade intelligent control mode	Parameters P165-P170 take effect when enabled
	3 (Default)	Disable cascade intelligent control mode	
P165	3°C	Loaded unit return temperature	Controls whether to turn on the next unit
P166	2°C	Derating unit return temperature	Controls whether to turn off the next unit
P167	3°C	Emergency stops return temperature	Controls whether to turn off the unit
P168	50%	Hot water mode unit activation ratio	Limit the total number of starting units
P169	100%	Heating/Cooling mode unit activation ratio	Limit the total number of starting units
P170	7Min	Load unit cycle	Time to activate the next unit
<b>NOTE:</b> Factory parameter adjustment is recommended to consult the manufacturer			

## SG Ready

If the unit is connected to the smart grid, this function can be enabled via parameter P255, refer to **Terminal Block Port Introduction (pg.21)** for wiring, and the unit will run in different modes according to the signals received:

Parameter	Status (0:Open 1:Close)		Running Mode	Description
	EVU	SG		
P255=0	1	1	Running DHW Mode	1. Set the hot water temperature to the sterilization temperature. 2. Turn on electric heater
	1	0	Running DHW Mode	1. Set the hot water temperature to the sterilization temperature. 2. Turn on electric heater
	0	1	Running current mode	
	0	0	Turn off hot water mode and enter ECO mode	1. Turn off the hot water mode, turn off the electric heater 2. Turn off after running P256 Min (default 3Min)
P255=1 (default)	Disable			

### Anti-Freeze Protection

In cold weather in winter, to protect the unit and water pipes, the unit will automatically enter the anti-freeze protection mode according to the ambient temperature. The operating mode of the unit is as follows:

Anti-Freeze Level	Running Mode
I	Running circulating water pump
II	Running circulating water pump and heating mode

### Wire Controller (TFT) Interface

The home page of the wired controller will display different control pages according to different modes. Single mode display page:

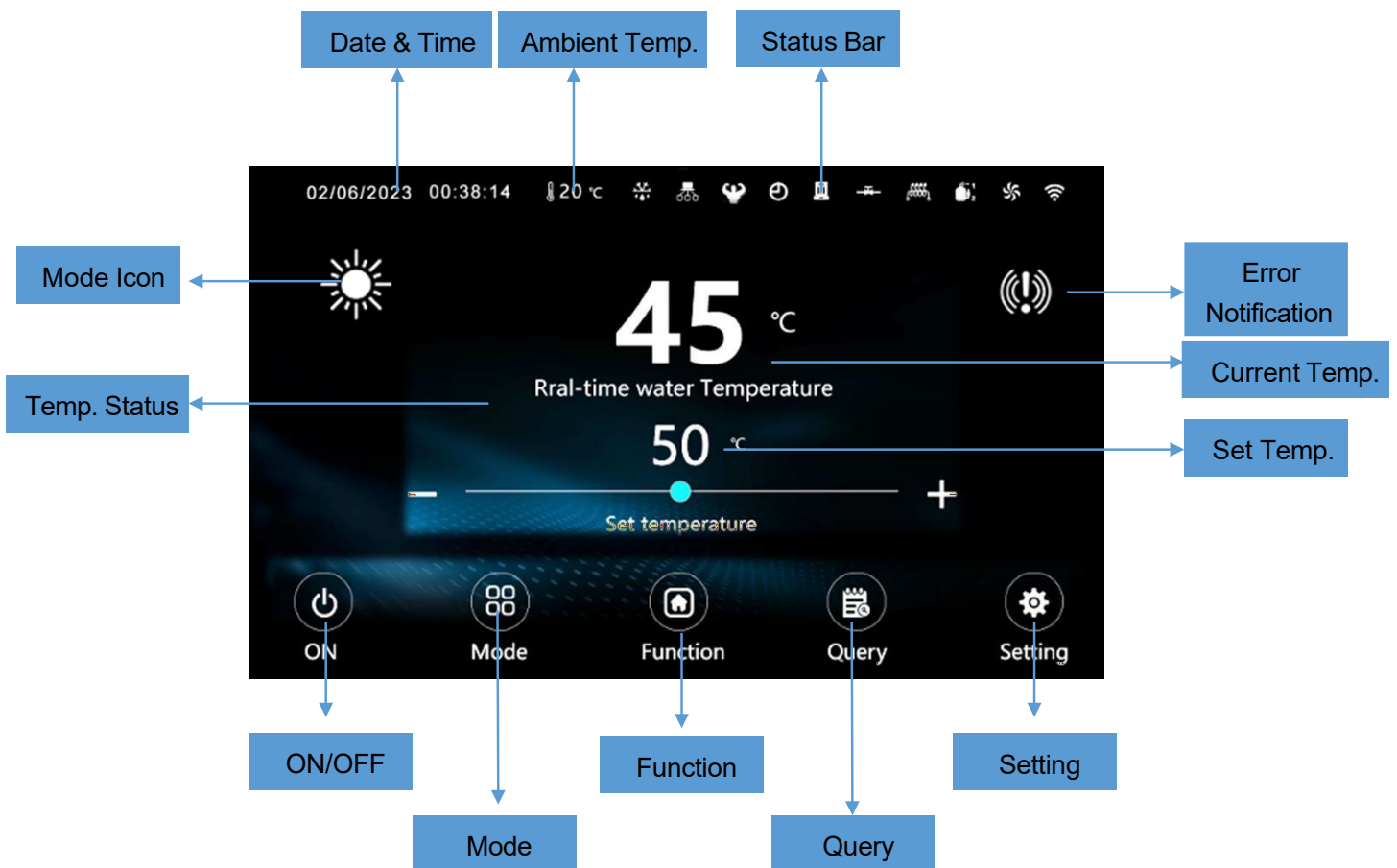

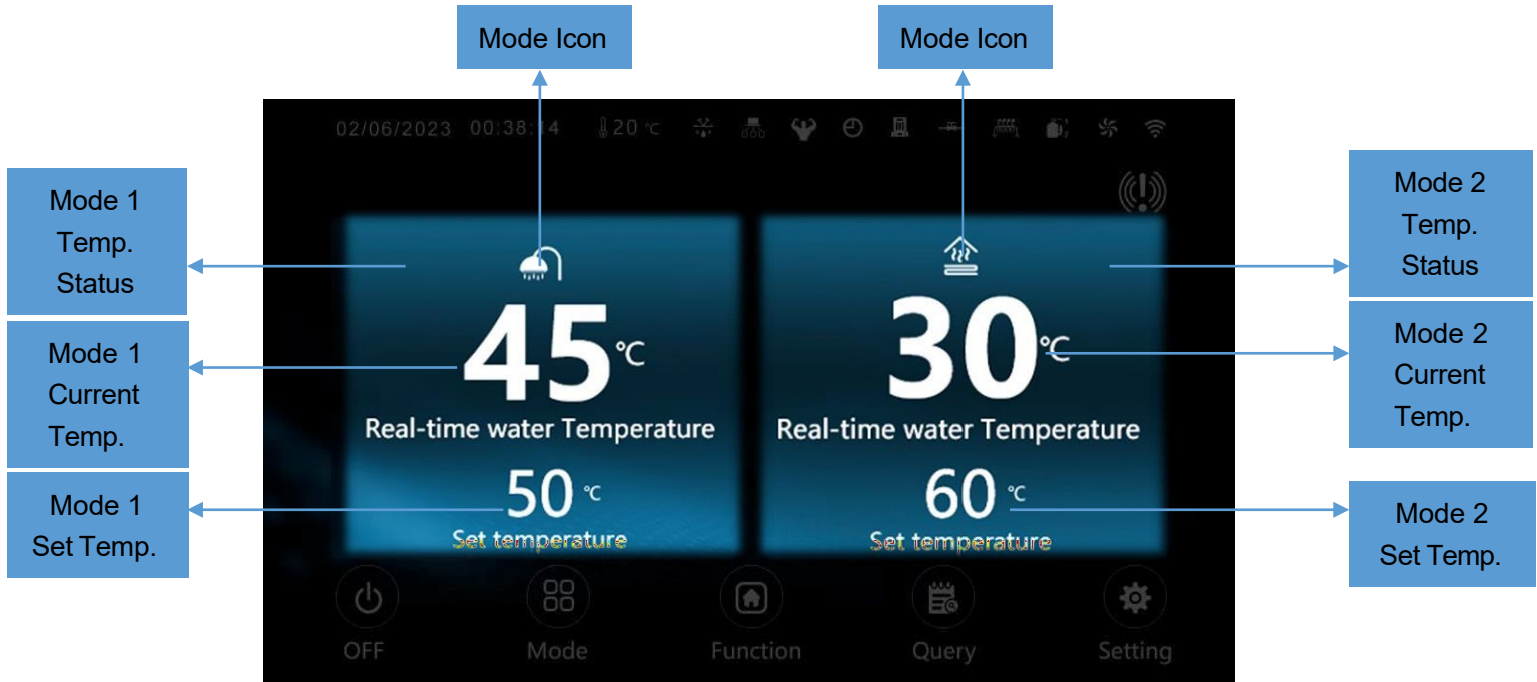

Combined mode display page:



### Mode Setting

It mainly introduces the operation mode settings introduced in **Unit Operation (pg.25)**. For more operations or settings, please refer to the "Operation Manual".

Running setting method:

1. Click "  " to enter the user function setting page.
2. Click "  User functions " to enter the mode selection page.

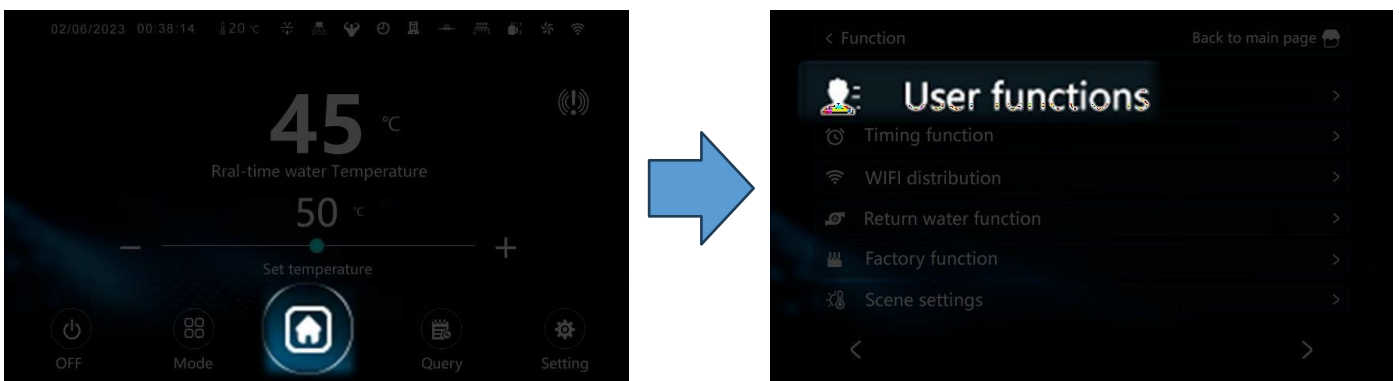

## Silent Mode

Click “ User functions” to enter the unit mode selection.

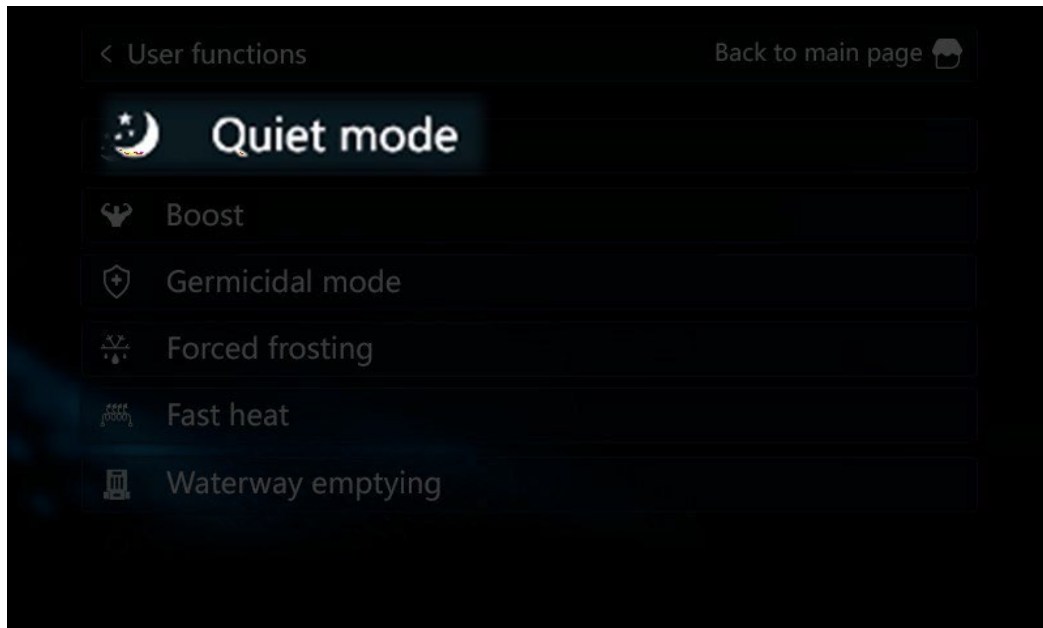

## Powerful Mode

Click “ User functions” to enter the unit mode selection.

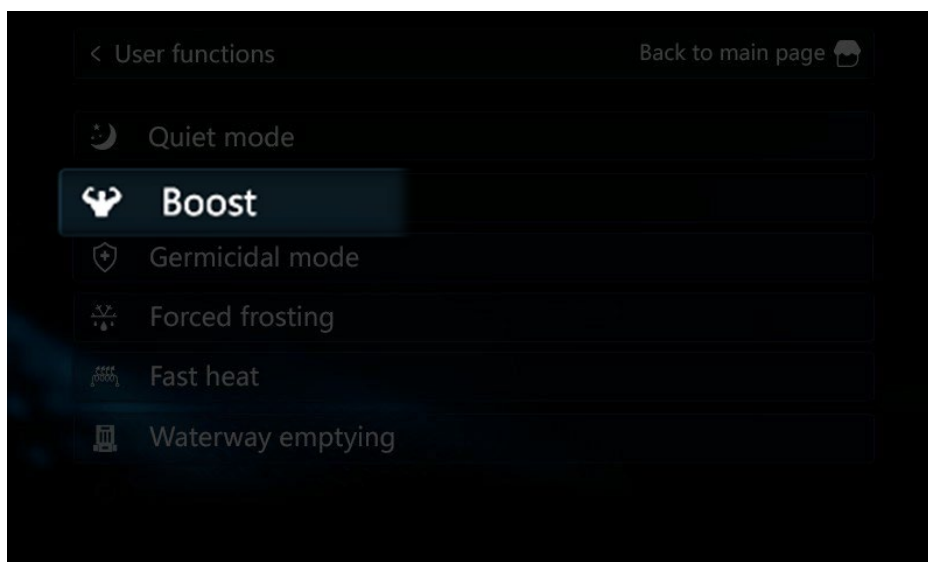



## Sterilization Mode

Click "  User functions " to enter the unit mode selection.

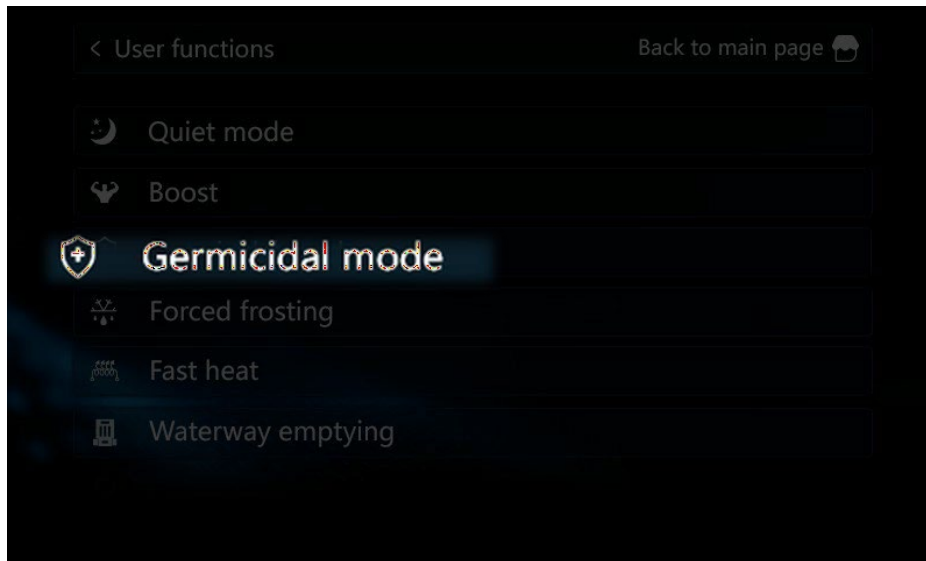

## Parameter Setting

This chapter mainly introduces the parameter setting operation method in **Unit Operation (pg.25)**. For specific operating modes and contents, please refer to **Unit Operation (pg.25)**.

User parameters enter method:



1. Click "Query" to enter the query page.
2. Click "User Parameter" to enter the user parameter setting page.

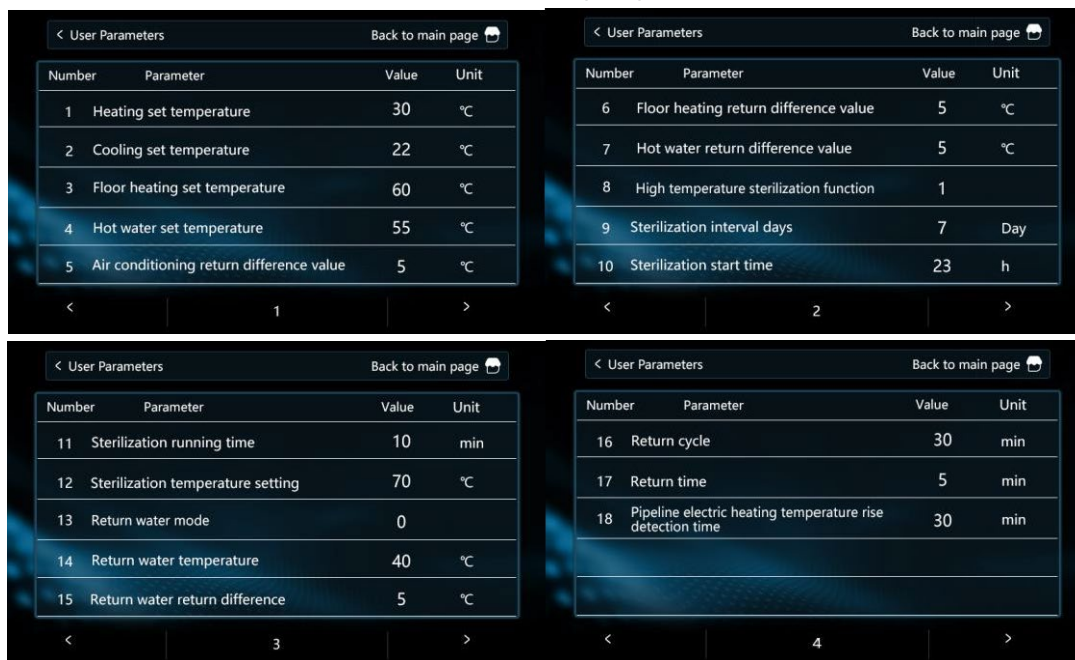

Factory Parameters enter method:



1. Click "Setting" to enter the setting page.



2. Click "Factory Parameters", enter password "998", to enter the factory parameters setting.

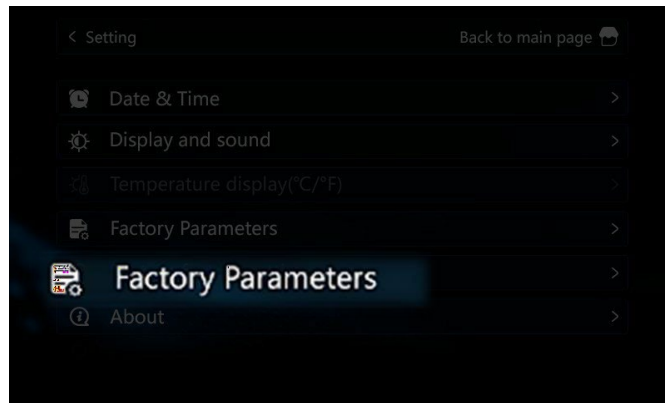

Parameter setting method:

1. Click the value that needs to modify the parameters.
2. Click "Set value: 50 °C"
3. Enter the value you need to set and click "↩" to confirm.
4. Click "OK" to set the value and the modification is successful.



Number	Parameter	Value	Unit
6	Floor heating return difference value	5	°C
7	Hot water return difference value	5	°C
8	High temperature sterilization function	1	
9	Sterilization interval days	7	Day
10	Sterilization start time	23	h



**NOTE:** Just set the parameters 9-12

### SG Ready Setting

The SG Ready function is disable by default, and parameters need to be modified to enable the SG Ready function.

1. Enter the factory parameter page and enter the password "998".
2. After finding the "P255" parameter, modify the corresponding value to enable the cascade. For details, refer to **SG Ready (pg.28)**.

3. After enable the SG Ready function, click "🏠" to enter the setting page, click ">" and find "

## Smart power grid

4. After entering the page, you can set the maximum running time of the unit when the SG signal and EVU signal are both disconnected.

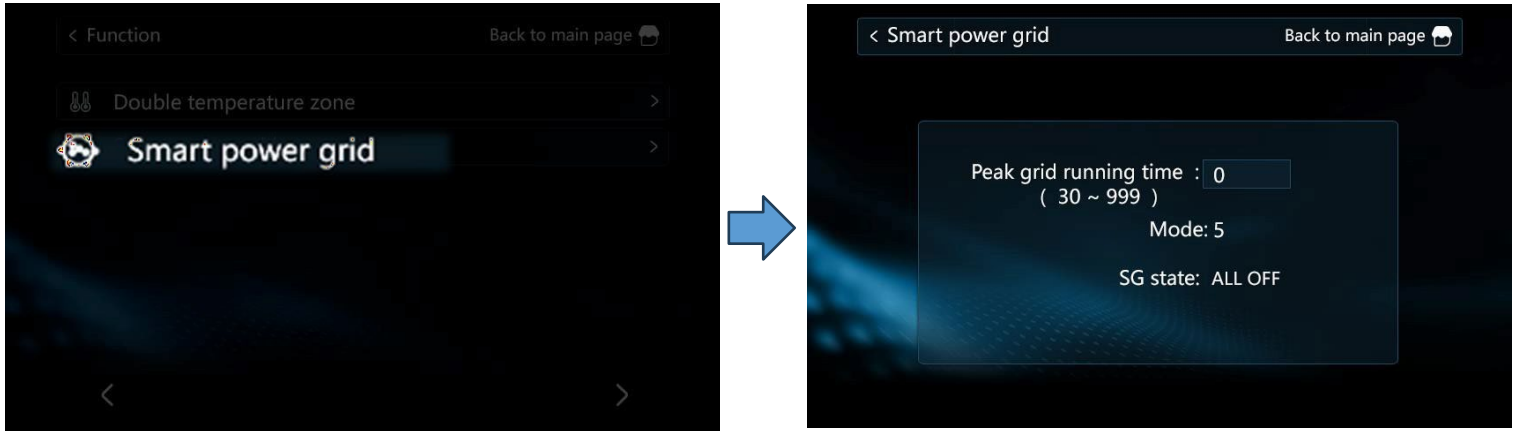

### Cascade Setting

Cascade is disable by default. If need to enable, it needs to modify parameters to enable the cascade control.

1. Enter the factory parameter page and enter the password "998".
2. After finding the "P164" parameter, modify the corresponding value to enable the cascade. For details, refer to **Cascade (pg.28)**.

### Running Status Query

The wire controller can query the running status of the unit. When the unit fails, the running status is provided to the factory for analysis to facilitate fault location.

Running status query method:

1. Click "System Parameter" to enter the query page.
2. Click "System Parameter" to query the running status of the unit.

Number	Parameter	Value	Unit
1	Compressor operating frequency	0	Hz
2	Fan running frequency/speed	0	Hz
3	Electronic expansion valve steps	0	P
4	EVI valve steps	0	P
5	AC input voltage	0	V

Running status query method in cascade mode:

Select the corresponding slave unit to query the running status of the corresponding unit.



### Factory Reset

In setting page, touch "Restore factory settings" to enter the page of resetting to factory setting. Touch "Yes" to confirm to reset to the factory setting.

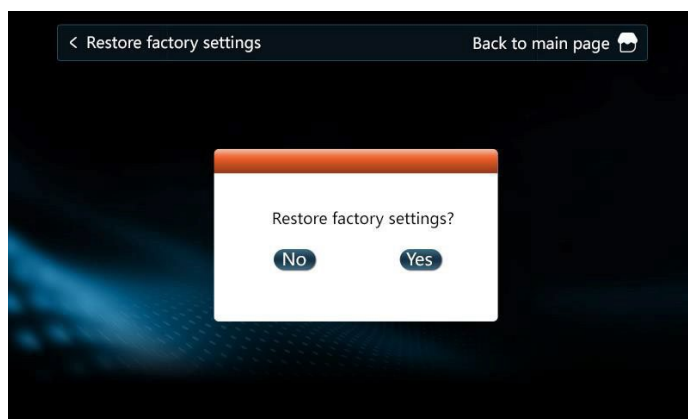

### APP & Unit Binding

The heat pump supports remote control by mobile phone. You need to download the APP in the app store and register an account to perform network distribution operations. The heat pump supports smart distribution network and AP distribution network. Under normal circumstances, it is recommended to use smart distribution network connection.

For more APP operations, please refer to "Operation Manual."

1. Search "Smart Life" in the App Store or scan the following QR code with your mobile phone to download.



2. Enter your account number and password to enter the APP main page.

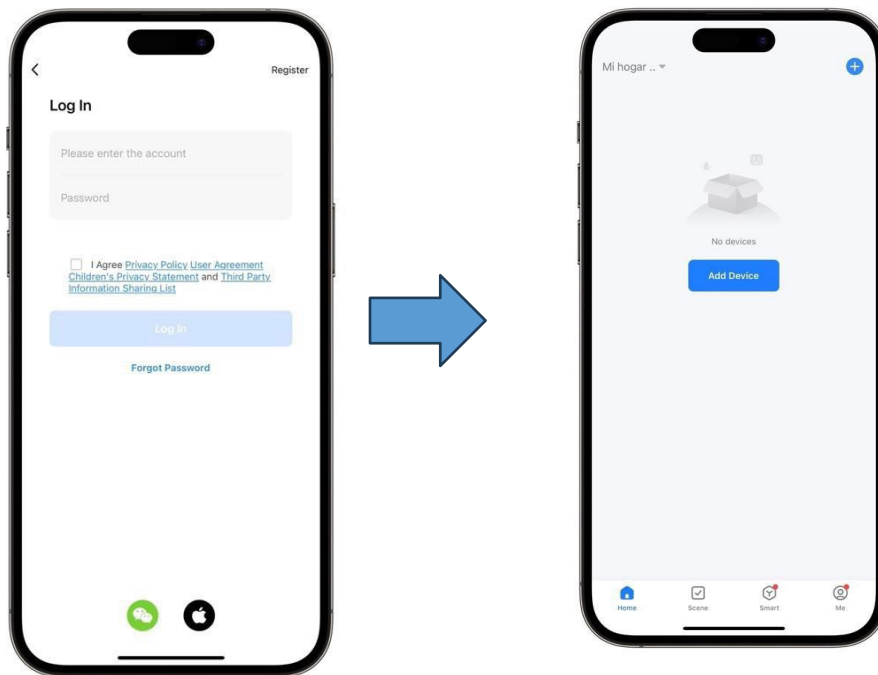

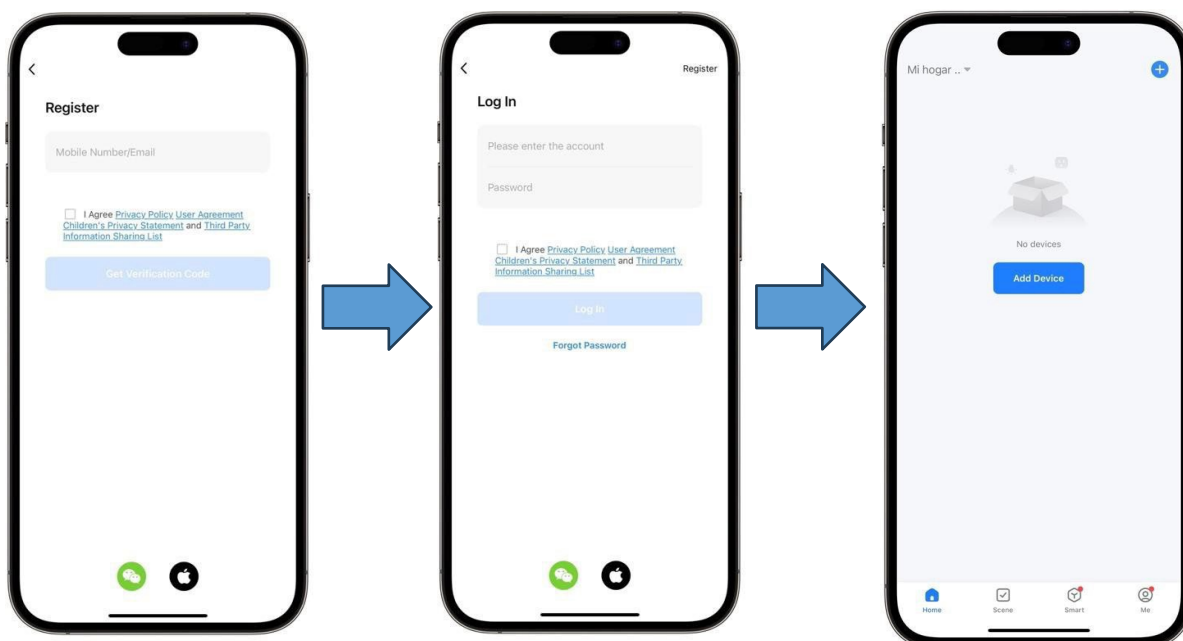

3. If you log in for the first time, you need to register an account. After registration is completed, enter your account password to enter the APP main page.



### Networking (Smart Mode)

Generally, it is recommended to use smart mode. The wire controller is required to be within WIFI coverage. The wire controller must first enter the network distribution mode. The following is the operation method:

1. Click " " on the wired controller to enter the function setting page.

2. Click "  **WIFI distribution** " to enter the WIFI distribution mode selection page.
3. Click "  **Intelligent WIFI Distribution Network** " to enter smart mode.

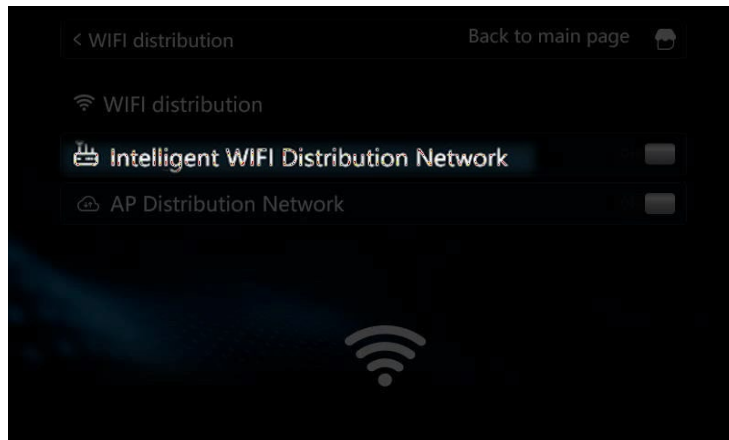

After the wire controller enters the network distribution mode, open the "Smart Life" APP on the mobile phone to enter device binding. Before binding, the mobile phone needs to be connected to the WIFI network, confirm that the Bluetooth and WIFI of the mobile phone are turned on and authorize the APP.

1. Place your mobile phone close to the wired controller and on the same WIFI network, open the APP and click "  ".

2. In the Smart mode, the APP will automatically identify the device, click "  ".

3. After entering the current WIFI account and password, wait for the APP to complete binding.

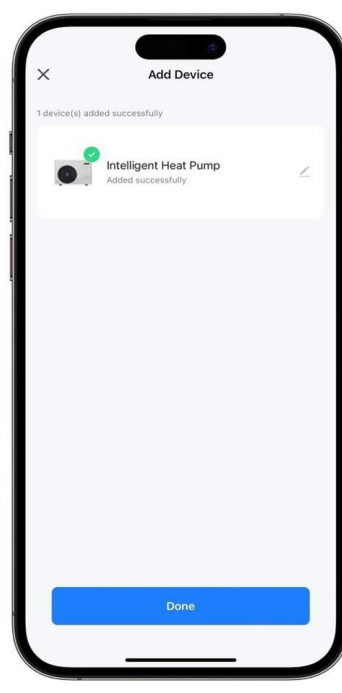
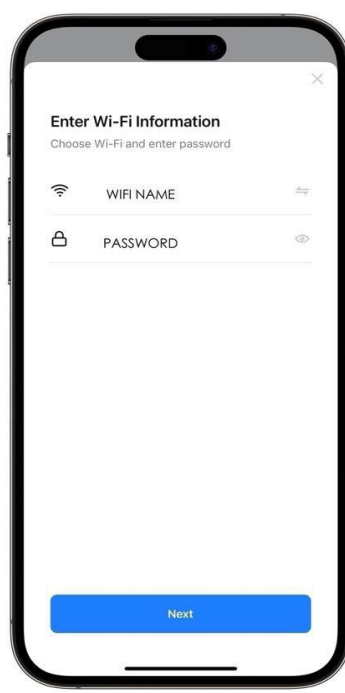
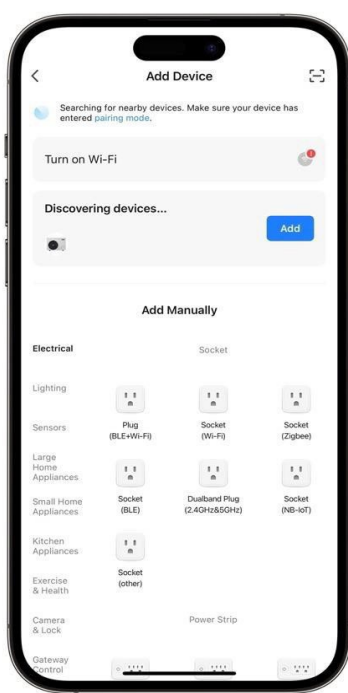
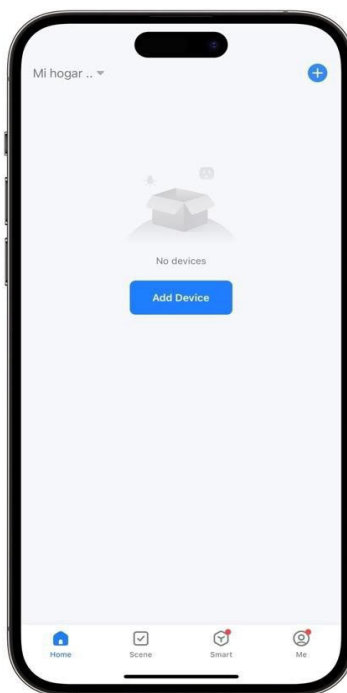



## Networking (AP Mode)

The wire controller is required to be within WIFI coverage.

The wire controller must first enter the network distribution mode.

The following is the operation method:

1. Click " " on the wired controller to enter the function setting page.
2. Click " WIFI distribution " to enter the WIFI distribution mode selection page.
3. Click " AP Distribution Network " to enter AP network mode.
4. At this time, the wire controller will transmit a WIFI hotspot named "smartlife-XXXX" or "SL-XXXX".



After the wire controller enters the network distribution mode, open the "Smart Life" APP on the mobile phone to enter device binding. Before binding, the mobile phone needs to be connected to the WIFI network, confirm that the Bluetooth and WIFI of the mobile phone are turned on and authorize the APP.

1. Place your mobile phone close to the wired controller and on the same WIFI network, open the APP and click "

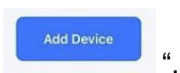

2. In the Smart mode, the APP will automatically identify the device, click " ".

3. Enter the account and password of the WIFI to be connected.

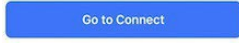
4. Click " " to enter the WIFI settings page, find the WIFI hotspot named "smartlife-XXXX" or "SL-XXXX" and connect.

5. Wait for the APP to complete binding

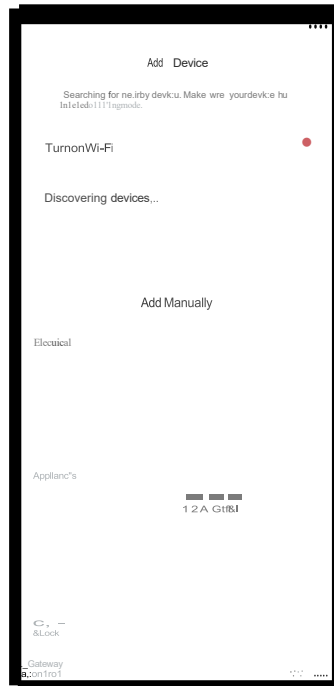
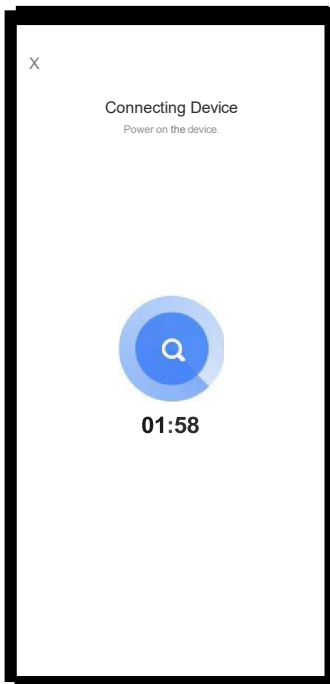
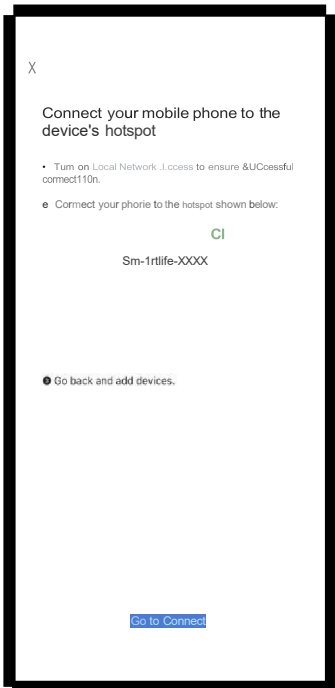
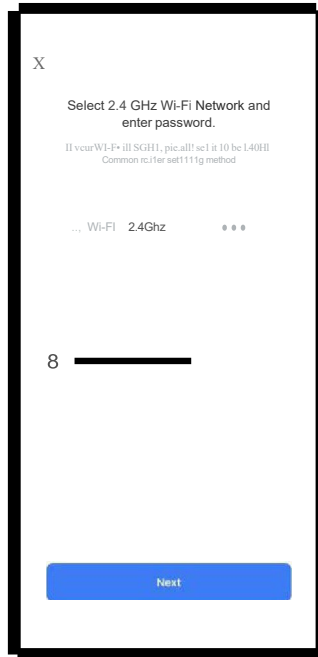
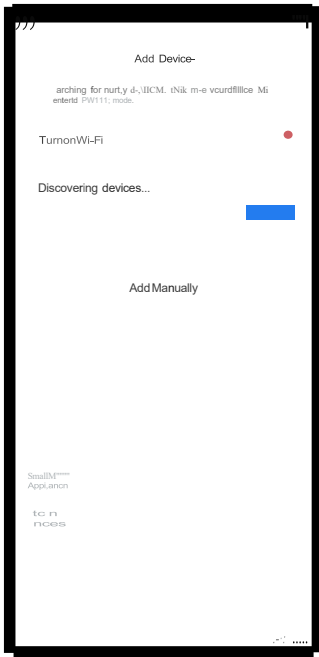



**Error Codes**  
**Motherboard**

<b>Error Code</b>	<b>Error Description</b>	<b>Troubleshooting</b>
E01	Wrong Phase	Power Supply Connect Wrong Phase
E02	Missing Phase	Power Supply Missing Phase
E03	Water Flow Failure	<ol style="list-style-type: none"> <li>1. Check whether the circulating water pump is normal and whether the water system is blocked.</li> <li>2. Check whether the water flow switch is normal and whether the installation direction is correct.</li> <li>3. Check whether the wiring of the water flow switch is correct or not.</li> <li>4. Check whether the water pump head meets the actual requirements</li> <li>5. Check whether the water pump is reversed and installed in the wrong direction.</li> </ol>
E04	Abnormal Communication between Motherboard and Remote Module (Reserved)	Check the communication connection between the motherboard and the remote module
E05	High Pressure Switch Failure	<ol style="list-style-type: none"> <li>1. Check pressure switch for damage, wiring error</li> <li>2. Check if there is too much refrigerant in the system.</li> <li>3. Check whether the fan is working properly and whether the water flow of the unit is normal.</li> <li>4. Check whether there is air or blockage in the fluorine system.</li> <li>5. Check whether the water-side heat exchanger is seriously caked with whitewash.</li> </ol>
E06	Low Pressure Switch Failure	<ol style="list-style-type: none"> <li>1. Check pressure switch for damage, wiring error</li> <li>2. Check if there is not enough refrigerant in the system.</li> <li>3. Check whether the fan is working properly</li> <li>4. Check whether there is air or blockage in the fluorine system.</li> </ol>
E09	Wire Controller Communication Failure	Check the communication connection between the wire controller and the main board
E10	Reserve	Reserve
E11	Out of Use Time	The free trial period has expired, enter the boot password

<b>Error Code</b>	<b>Error Description</b>	<b>Troubleshooting</b>
E12	Exhaust Temp. Too High	1. Fluorine system clogging
		2. Lack of refrigerant in the fluorine system or bad sensor
E14	Water Tank Temp. Sensor Failure	1. The sensor wire is loose or damaged
		2. Sensor is damaged
		3. The motherboard port is damaged
E15	Water Inlet Temp. Sensor Failure	1. The sensor wire is loose or damaged
		2. Sensor is damaged
		3. The motherboard port is damaged
E16	Coil Temp. Sensor Failure	1. The sensor wire is loose or damaged
		2. Sensor is damaged
		3. The motherboard port is damaged
E18	Exhaust Temp. Sensor Failure	1. The sensor wire is loose or damaged
		2. Sensor is damaged
		3. The motherboard port is damaged
E20	Indoor Ambient Temp. Sensor Failure	1. The sensor wire is loose or damaged
		2. Sensor is damaged
		3. The motherboard port is damaged
E21	Outdoor Ambient Temp. Sensor Failure	1. The sensor wire is loose or damaged
		2. Sensor is damaged
		3. The motherboard port is damaged
E22	DHW Return Water Temp. Sensor Failure	1. The sensor wire is loose or damaged
		2. Sensor is damaged
		3. The motherboard port is damaged
E23	Water Outlet Temp. Too Low in Cooling Mode	1. Check whether the water flow is too low or no water flow
		2. Check if the water outlet sensor is damaged
		3. Fluorine system clogging
E24	Antifreeze Temp. Sensor Failure (Fluorine Circuit)	1. The sensor wire is loose or damaged
		2. Sensor is damaged
		3. The motherboard port is damaged
E25	Reserve	Reserve
E26	Antifreeze Temp. Sensor Failure (Water Circuit)	1. The sensor wire is loose or damaged
		2. Sensor is damaged

Error Code	Error Description	Troubleshooting
		3. The motherboard port is damaged
E27	Water Outlet Temp. Sensor Failure	1. The sensor wire is loose or damaged
		2. Sensor is damaged
		3. The motherboard port is damaged
E29	Suction Temp. Sensor Failure	1. The sensor wire is loose or damaged
		2. Sensor is damaged
		3. The motherboard port is damaged
E30	Suction Temp. Sensor Failure	1. The sensor wire is loose or damaged
		2. Sensor is damaged
		3. The motherboard port is damaged
E31	Water Pressure Failure	1. Water pressure switch wiring error
		2. Water pressure switch failure
E32	Water Outlet Temp. Sensor T15 Failure	1. Water flow is not enough
		2. Sensor failure
E33	High Pressure Sensor Failure	1. The sensor wire is loose or damaged
		2. Sensor is damaged
		3. The motherboard port is damaged
E34	Low Pressure Sensor Failure	1. The sensor wire is loose or damaged
		2. Sensor is damaged
		3. The motherboard port is damaged
E37	Large Temp. Difference between Water Inlet and Outlet	1. The water inlet or outlet sensor is damaged
		2. Water inlet or outlet sensor not placed or in the wrong position
		3. Water flow is not enough
E38	Fan Failure	Fan driver board or motor failure
E42	Cooling Coil Temp. Sensor Failure	1. The sensor wire is loose or damaged
		2. Sensor is damaged
		3. The motherboard port is damaged
E44	Ambient Temp. Too Low	Normal protection
E47	Economizer Inlet Temp. Sensor Failure	1. The sensor wire is loose or damaged
		2. Sensor is damaged
		3. The motherboard port is damaged
E48	Economizer Inlet Temp. Sensor	1. The sensor wire is loose or damaged

Error Code	Error Description	Troubleshooting
	Failure	2. Sensor is damaged
		3. The motherboard port is damaged
E49	Economizer Outlet Temp. Sensor Failure	Same as E47
E51	High Pressure Too High	Same as E05
E52	Low Pressure Too Low	Same as E06
E55	Expansion Board Communication Failure	1. Poor contact or broken signal wire
		2. Expansion board damage
		3. Motherboard damage
E80	Power Supply Error	Single-phase power supply unit detects a three-phase electrical signal
E88	Inverter Drive Module Protection	Compressor or compressor driver board is damaged, specific faults see 4.2.2
E94	Built-in pump over/under voltage	1. Input power supply voltage < 165V
		2. Input power supply voltage > 265V
		3. Electronic components on the pump drive board are damaged or damp
		4. Water pump failure
E96	Compressor Drive Board Communication Failure	1. Poor contact or broken signal wire
		2. Electronic components on the motherboard are damaged or damp.
		3. Compressor drive board on the electronic components are damaged or moisture
		4. Compressor drive board power supply is not powered on
E98	Fan Board Communication Failure	1. Poor contact or broken signal wire
		2. Electronic components on the motherboard are damaged or damp.
		3. Fan drive board on the electronic components are damaged or moisture
		4. Fan drive board power supply is not powered on
EA1	Cascade Model Mismatch	Different series of units are not allowed to be cascaded
EA2	Solar Water Heater Temp. Sensor Failure	1. The sensor wire is loose or damaged
		2. Sensor is damaged
		3. The motherboard port is damaged
EA3	Zone 2 Temp. Sensor Failure	1. The sensor wire is loose or damaged

Error Code	Error Description	Troubleshooting
		2. Sensor is damaged
		3. The motherboard port is damaged
EA4	Buffer Tank Temp. Sensor Failure	1. The sensor wire is loose or damaged
		2. Sensor is damaged
		3. The motherboard port is damaged
EA5	Total Water Outlet Temp. Sensor Failure	1. The sensor wire is loose or damaged
		2. Sensor is damaged
		3. The motherboard port is damaged

### Driver Board (Compressor)

Compressor Drive Error Description Table		
E88	P1	IPM Module Overheat and Shutdown
	P2	Compressor Driver Failure
	P3	Compressor Overcurrent
	P4	Input Voltage Missing Phase
	P5	IPM Supply Voltage Failure
	P6	Power Component Overheating and Shutdown
	P7	Pre-charge Circuit Voltage Failure
	P8	DC Bus Overvoltage
	P9	DC Bus Undervoltage
	P10	AC Input Undervoltage
	P11	AC Input Overvoltage
	P12	Input Voltage Sampling Failure
	P13	DSP and PFC Communication Failure
	P14	Board Radiator Temp. Sensor Failure
	P15	DSP and Communicate Board Communication Failure
	P16	Communication Failure with Motherboard
	P17	Compressor Overcurrent Alarm
	P18	Compressor Weak Magnetic Protection Alarm
	P19	IPM Overheat Alarm
	P20	PFC Overheat Alarm
	P21	AC Input Overcurrent Alarm
	P22	EEPROM Error Alarm
	P23	N/A

Compressor Drive Error Description Table		
P24	EEPROM Refresh Complete	
P25	Temperature Sensing Failure Limit	
P26	AC Undervoltage Frequency Limit Protection Alarm;	
P27	N/A	
P28	N/A	
P29	N/A	
P30	N/A	
P31	N/A	
P32	N/A	
P33	IPM Module Overheat and Shutdown	
P34	Compressor Missing Phase	
P35	Compressor Overload	
P36	Input Current Sampling Failure	
P37	IPM Supply Voltage Failure	
P38	Pre-charge Circuit Voltage Failure	
P39	EEPROM Failure	
P40	AC Input Overvoltage Failure	
P41	Microelectronics Failure	
P42	Compressor Type Code Failure	
P43	Current Sampling Signal Overcurrent	
Wire controller blinks to cycle through E88 and above codes		

## Parameters & Explanations

### Running Parameter

No.	Description	Setting Range	No.	Description	Setting Range
1	Compressor Running Frequency	0~150Hz	31	System 2 Compressor Running Frequency	
2	Fan Running Speed	0~999Hz	32	System 2 Fan Running Speed	
3	EEV Open Step	0~480P	33	System 2 EEV Open Step	
4	EVI Valve Open Step	0~480P	34	System 2 EVI Valve Open Step	
5	AC Input Voltage	0~500V	35	System 2 AC Input Voltage	
6	AC Input Current	0~50.0A	36	System 2 AC Input Current	
7	Compressor Phase Current	0~50.0A	37	System 2 Compressor Phase Current	
8	Compressor IPM Temp.	-40~140°C	38	System 2 Compressor IPM Temp.	
9	High Pressure Saturation Temp.	-50~200°C	39	System 2 High Pressure Saturation Temp.	

No.	Description	Setting Range	No.	Description	Setting Range
10	Low Pressure Saturation Temp.	-50~200°C	40	System 2 Low Pressure Saturation Temp.	
11	Ambient Temp. T1	-40~140°C	41	System 2 Outer Coil Temp.	
12	Outer Coil Temp. T2	-40~140°C	42	System 2 Inner Coil Temp.	
13	Inner Coil Temp. T3	-40~140°C	43	System 2 Suction Temp.	
14	Suction Temp. T4	-40~140°C	44	System 2 Exhaust Temp.	
15	Exhaust Temp. T5	0~150°C	45	System 2 Economizer Inlet Temp.	
16	Water Inlet Temp. T6	-40~140°C	46	System 2 Economizer Outlet Temp.	
17	Water Outlet Temp. T7	-40~140°C	47	Reserve	
18	Economizer Inlet Temp. T8	-40~140°C	48	Reserve	
19	Economizer Outlet Temp. T9	-40~140°C	49	Reserve	
20	Current Unit Tool Number	0~120	50	Reserve	
21	DHW Tank Temp.	-40~140°C	51	Solar Water Heater Temp.	
22	Plate Heat Exchanger Exhaust Temp.	-40~140°C	52	Zone 2 Temp.	
23	Driver Manufacturer	0~10	53	Butter Tank Temp.	
24	Water Pump Speed PWM	0~100%	54	Total Water Outlet Temp.	
25	Water Flow	3~100L/min	55	Unit B Phase Input Voltage	
26	DHW Return Water Temp.	-40~140°C	56	Unit B Phase Input Current	
27	Unit Input Voltage	0-500V	57	Unit C Phase Input Voltage	
28	Unit Input Current	0.00A-99.99A	58	Unit C Phase Input Current	
29	Unit Input Power	0.00-99.99KW	59	Smart Grid Status	
30	Unit Power Consumption	0-9999Kw.h	60	Zone 2 Mixing Valve Opening	

### Factory Parameter

No.	Description	Default Value	Setting Range	Note
L12	Sterilization	0	0~2	
L13	Days between Sterilizations	7	5~30	
L14	Sterilization Start-up Time	23:00	00:00-24:00	
L15	Sterilization Running Time	10	0-50Min	
L16	Sterilization Temp Setting	70°C	50-80°C	
L22	DHW return water Setting	0	0~3	0-Disable / 1-Continuous return / 2-Cycle return / 3-Temperature
L23	Return Water Temp Setting	40°C	20~65°C	
L24	Return Water Return Temp Differential	5°C	1~15°C	
L25	Return Water Interval Period	30min	3~90min	
L26	Return Water Running Period	5min	1~30min	
P22	Ambient temperature value- Unit no starting	-15	-15~40	If Ambient Temp. ≤P22 then enter defrost

No.	Description	Default Value	Setting Range	Note
P24	Ambient temperature value- Allow electric heater to start	0	-10~10°C	
P25	Overprotection value- Inlet and outlet water temperature differential	0	-10~10°C	
P26	Compensation value-Return water temperature	5	0~10°C	
P27	Floor heating return differential value	5	0~10°C	
P28	Water Pump Control-Unit shutdown when reaching temperature	0	0~1	0-Running /1-Stop /2-Running in cooling mode /3-Running in cooling/heating mode /4-Running in underfloor heating mode
P29	Anti-freeze-water pump running time	2	0~10min	
P30	Defrost mode selection	0	0~2	0-Intelligent control /1-Timing control/ 2-Rapid control /3-Dew point control
P31	Defrosting - cumulative runtime	45	0~120	
P32	Defrosting - coil temperature value	-5	-30~0	
P33	Defrosting - temperature differential 1	9	0~20	
P34	Defrosting - temperature differential 2	7	0~20	
P35	Maximum defrosting time	10	0~30	
P36	Exit defrosting - coil temperature	12	0~30	
P37	Shutdown mode - Reaching target temperature	0	0~2	0-Intelligent shutdown/1- Temperature shutdown /2- Cooling intelligent
P38	Opening degree constant - Heating main valve	300	-999~999	
P48	Enable/Disable Hot Water Tank temperature sensor	0	0~1	0-Disable/1-Enable
P88	Silent mode - compressor maximum frequency	50	20-70Hz	
P89	Silent mode - fan motor maximum frequency	40	20-60Hz	
P95	Cascade - water pump operation mode	0	0-1	0-Together control /1- Independent control
P96	DHW differential value	5	0~10°C	
P97	Water tank temperature automatic compensation	0	0~1	0-Enable/1-Disable
P98	Water tank temperature manual compensation	0	-10~10°C	
P99	Water pump speed regulation temperature differential	5	2~10°C	



No.	Description	Default Value	Setting Range	Note
P100	PWM pump minimum speed	50	20~80%	Percentage of RPM
P101	Unit water pump control mode (Master)	1	0~1	0-ON/OFF /1-PMW
P115	Unit type selection	1	0~5	0-2-unit /1-3-unit
P116	Unit temperature control mode	0	0~1	0-Water Inlet Temp./1-Water Outlet Temp.
P117	Ambient temperature - Allow access to anti-freeze	5	0~10°C	
P118	Outlet water temperature - Allow access to anti-freeze	3	0~20°C	
P119	Refrigerant type	2	0~20	1-R410A/2-R32/3-R290
P139	Buffer tank electric heating	0	0/1	0-Enable/1-Disable
P140	DHW electric heating			0-Enable/1-Disable
P150	Water pump - secondary heating/cooling system	0/1/2/3	2	
P151	Return differential - Hot water heat source	0-40	0	
P152	Return differential - Heating heat source	0-40	0	
P153	Upper temperature limit - Hot water heat source combined temperature	15-80	70	
P154	Upper temperature limit - Heating water heat source combined temperature	15-80	60	
P161	Auxiliary pump selection	0/1/2/3/4	0	0-DHW/1-Cooling/2-Underfloor heating/3-Heating&Cooling/4-Above all
P162	Anti-freezing interval - Hot water pipes	0~360	90	If set to 0, mean disable
P163	Water pump speed regulation - Minimum speed	0~70	30	L/min
P164	Level control	0/3	3	0-Enable/3-Disable
P165	Load return differential	1~15°C	3	
P166	Lightening back to the poor	1~15°C	2	
P167	Stop back to the poor	1~15°C	3	
P168	Hot water mode start ratio	1~100%	50	
P169	Non-hot water mode start ratio	1~100%	100	
P170	Loading cycle	3~60min	7	
P179	Target frequency - Power mode	0~40Hz	15	
P180	Target frequency upper limit- Power mode	0~40Hz	5	
P181	Defrost selection - Evaporate side	0~2	0	0-Current/1-Heating/2-DHW
P182	Pipe electric heating option	0~2		0-3kW+6kW/ 1- 3kW/ 2-6kW/ 3- Disabled
P255	Smart Grid Options - On/Off	0~1		

No.	Description	Default Value	Setting Range	Note
P256	Smart Grid Options - Peak grid running time	30~999		
P257	Dual temperature zone selection	0~2		
P258	Mixed water regulating valve cycle	5~20		
P259	Mixing valve full cycle time	0~180		
P260	Maximum water pump speed	50~99	99	%
P261	Water pump speed - at constant temperature	20~99	30	%





# WATERWARE

*Proud members of*



[waterware.co.nz](http://waterware.co.nz)  
[info@waterware.co.nz](mailto:info@waterware.co.nz)  
+64 9 273 9191

