

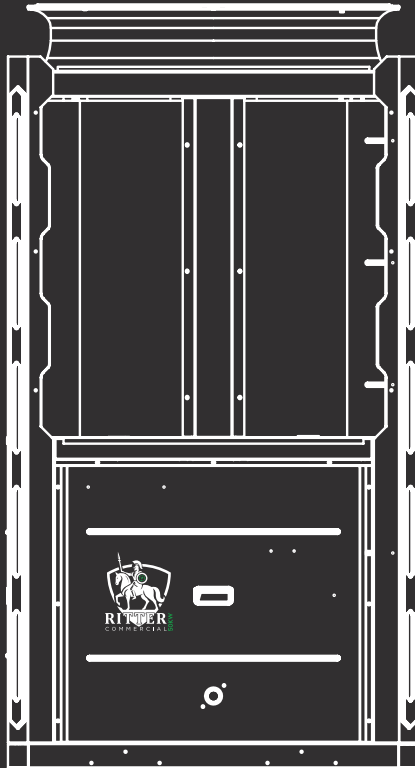

RITTER
COMMERCIAL 50KW



R290 AIR TO WATER HEAT PUMP



Installation and Instruction Manual

Powered by
WATERWARE

waterware.co.nz

CONTENT

1	Preface	1
2	Safety Precaution	2
	(1) Mark notes	2
	(2) Icon Notes	2
	(3) Warning	3
	(4) Attention	4
3	Specification	5
	(1) Appearance and structure of the heat pump	5
	(2) The data of unit	5
	(3) Unit dimension	6
4	Installation	7
	(1) Application of heat pump	7
	(2) Choose a right heat pump unit	8
	(3) Installation method	8
	(4) Installation place	9
	(5) Refrigerant charge	9
	(6) Water loop connection	10
	(7) Power supply connection	10
	(8) Location of the unit	10
	(9) Transit	11
	(10) Trial Running	12
5	Operation and Use	13
	5.1 Main interface display and function	13
	5.2 Instructions for operation of wire controller	15
	5.3 Electronic control failure code and troubleshooting table	27
6	Appendix	34
	(1) Appendix 1	34
	(2) Appendix 2	35

Preface

- In order to provide the customers with high quality, strong reliability and good versatility product, this heat pump is produced by strict design and manufacture standards.

This manual includes all the necessary information about installation, debugging, discharging and maintenance. Please read this manual carefully before you open or maintain the unit.

The manufacture of this product will not be held responsible if someone is injured or the unit is damaged, as a result of improper installation, debugging, unnecessary maintenance which is not in line with this manual.

The unit must be installed by qualified personnel.

- It is vital that the below instructions are adhered to at all times to keep the warranty.

—The unit can only be opened or repaired by qualified installer or an authorised dealer.

—Maintenance and operation must be carried out according to the recommended time and frequency, as stated in this manual.

—Use genuine standard spare parts only.

Failure to comply with these recommendations will invalidate the warranty.

- Inverter air source water heat pump is a kind of high efficiency, energy saving and environment friendly equipment, which is mainly used for house warming. It can work with any kind of indoor unit such fan coil, radiator, or floor heating pipe, by provide warm or hot water. One unit of monobloc heat pump can also work with several indoor units.

The air source water heat pump unit is designed to have heat recovery by using super heater which can provide hot water for sanitary purpose.

This series of heat pump unit owns following features:

1 Advanced controlling

The PC microcomputer based controller is available for the users to review or set the running parameters of the heat pump. Centralized controlling system can control several units by PC.

2 Nice appearance

The heat pump is designed with beautiful looking. The monobloc one has the water pump included which is very easy for installation.

3 Flexible installation

The unit has smart structure with compact body, just simple outdoor installation is needed.

4 Quiet running

High quality and efficient compressor, fan and water pump is used to ensure the low noise level with insulation.

5 Good heat exchange rate

The heat pump unit use special designed heat exchanger to enhance whole efficiency.



6 Large working range

This series of heat pump is designed to work under different working conditions as low as -15 degrees for heating.



Safety Precaution

To prevent the users and others from the harm of this unit, and avoid damage on the unit or other property, and use the heat pump properly, please read this manual carefully and understand the following information correctly.

Mark Notes



Mark	Meaning
 WARNING	A wrong operation may lead to death or heavy injury on people.
 ATTENTION	A wrong operation may lead to harm on people or loss of material.



Icon notes



Icon	Meaning
	Prohibition. What is prohibited will be nearby this icon
	Compulsory implement. The listed action need to be taken.
	ATTENTION (include WARNING) Please pay attention to what is indicated.

Safety Precaution

Warning

Installation	Meaning
 Professional installer is required.	The heat pump must be installed by qualified personals, to avoid improper installation which can lead to water leakage, electrical shock or fire.
 Earthing is required	Please make sure that the unit and power connection have good earthing, otherwise may cause electrical shock.

Operation	Meaning
 PROHIBITION	DO NOT put fingers or others into the fans and evaporator of the unit, otherwise harm may be occurred.
 Shut off the power	When there is something wrong or strange smell, the power supply need to be shut off to stop the unit. Continue to run may cause electrical short or fire.

Move and repair	Meaning
 Entrust	When the heat pump need to be moved or installed again, please entrust dealer or qualified person to carry it out. Improper installation will lead to water leakage, electrical shock, injury or fire.
 Entrust	It is prohibited to repair the unit by the user himself, otherwise electrical shock or fire may be occur.
 Prohibit	When the heat pump need to be repaired, please entrust dealer or qualified person to carry it out. Improper movement or repair on the unit will lead to water leakage, electrical shock, injury or fire.









Do not use means to accelerate the defrosting process or to clean, Other than those recommended by the manufacturer.

The appliance shall be stored in a room and install in the environment without continuously operating or potential ignition sources (for example: open flames, an operating gas appliance or an operating electric heater or Electric Spark or hot object)

Safety Precaution

ATTENTION

Installation	Meaning
 Installation Place	The unit CANNOT be installed near the flammable gas. Once there is any leakage of the gas, fire can be occur.
 Fix the unit	Make sure that the basement of the heat pump is strong enough, to avoid any decline or fall down of the unit
 Need circuit breaker	Make sure that there is circuit breaker for the unit, lack of circuit breaker can lead to electrical shock or fire.

Operation	Meaning
 Check the installation basement	Please check the installation basement in a period (one month), to avoid any decline or damage on the basement, which may hurt people or damage the unit
 Switch off the power	Please switch off the power for clean or maintenance.
 Prohibition	It is prohibited to use copper or iron as fuse. The right fuse must be fixed by electrician for the heat pump.
 Prohibition	It is prohibited to spray the flammable gas to the heat pump, as it may cause fire.

Specification

1. Appearance and structure of the heat pump

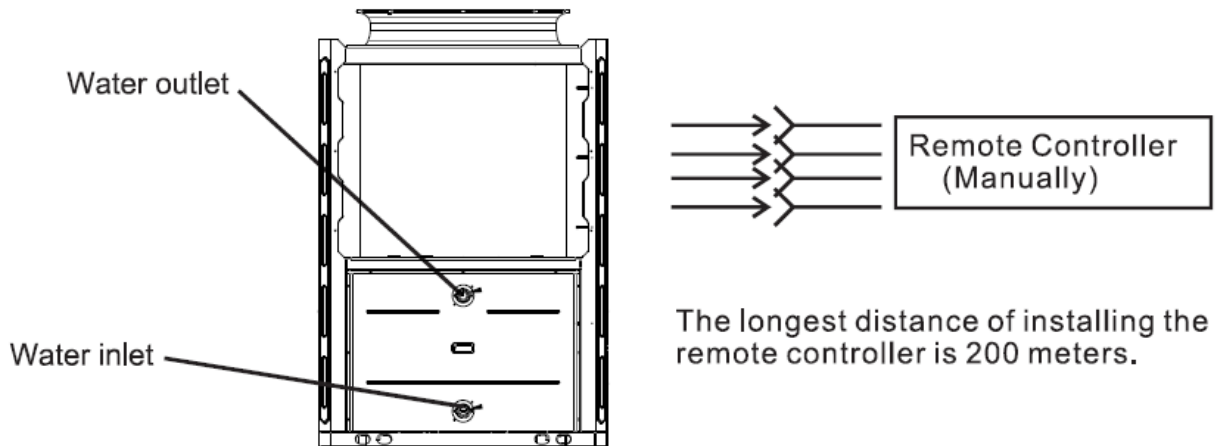

2. The data of unit

*** REFRIGERANT : R290

Model		PASRW150S-BP-PS-D
Heating Capacity(A)	kW	13.63~50.00
Heating Power Input(A)	kW	4.36-16.00
Cooling Capacity(B)	kW	9.27-34.00
Cooling Power Input(B)	kW	3.91-14.35
Hot Water Capacity(C)	kW	16.36-70.00
Hot Water Power Input(C)	kW	5.29-19.40
Hot Water Capacity (D)	kW	8.24-28.77
Hot Water Power Input(D)	kW	6.01-22.00
Rated Power Input	kW	19.4
Rated Current Input	A	30.0
Power Supply		380-415V/3N-/50Hz
Compressor Quantity		2
Compressor Model		Rotary
Fan Quantity		1
Fan Power Input	W	750
Fan Rotate Speed	RPM	850
Refrigerant	kg	R290/1.5 kg*2
Noise	dB(A)	45-69
Water Connection	Inch	1.5
Water Flow Volume	m ³ /h	9
Unit Net Dimensions (L/W/H)	mm	1816 x 980 x 1198mm
Unit Shipping Dimensions (L/W/H)	mm	2000 x 1000 x 1200mm
Net Weight	kg	363
Shipping Weight	kg	375

A: AMBIENT TEMP.(DB/WB): 7°C/6°C,WATER TEMP.(IN/OUT):30°C/35°C

B: AMBIENT TEMP.(DB/WB): 35°C/24°C,WATER TEMP.(IN/OUT):12°C/7°C

C: AMBIENT TEMP.(DB/WB): 20°C/15°C,WATER TANK TEMPERATURE CIRCULATION FROM 15°C TO 55°C

D: AMBIENT TEMP.(DB/WB): -10°C,WATER TEMP.(IN/OUT):50°C/55°C

BS EN 14511-1-2013 Air conditioner, whole liquid cooling machine, electric compressor.

Part2: Test condition ; Part3:Test method ; Part4:related requirements.

Specification

3. Unit dimension

Models: PASRW150S-BP-PS-D

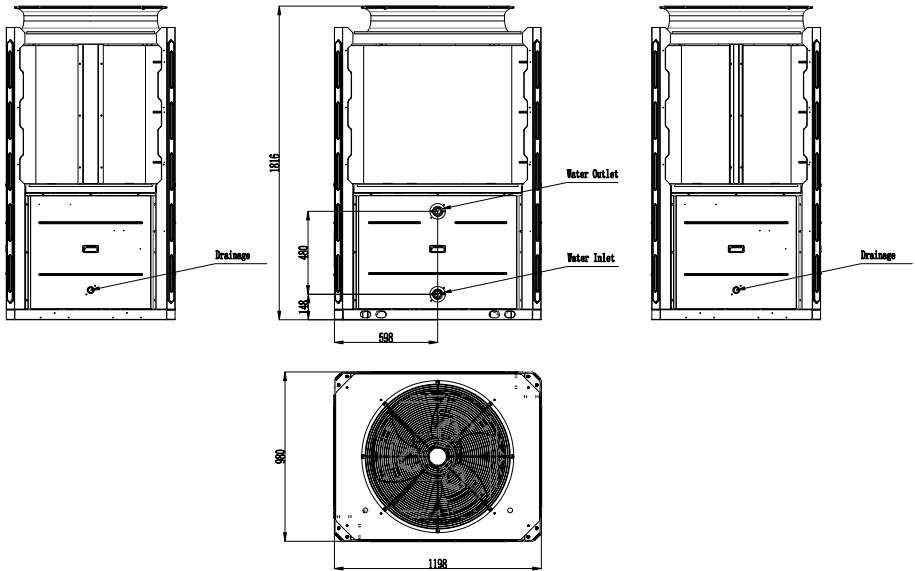

Installation

Unit features

1. Plate heat exchanger

Use the SWEP efficient heat exchanger with small size and high efficiency.

2. Environmentally friendly refrigerant

Use the new generation of environmentally friendly refrigerant R290, which is harmless to the ozone sphere.

3. Heating in frigid environment.

Optimized designed unit can achieve the heating function normally even when the ambient temperature is -25°C .

4. Infusing refrigerant

The Heat Pump are lack of refrigerant and full of High-pressure nitrogen instead when Ex-factory . Before operating ,remember follow Operation Manual infusing therefrigerant .

5. Installation Environment

The refrigerant R290 are flammable and explosive ,It's prohibit install in one environment which have operating or potential ignition sources .

2 Choose a right heat pump unit

2.1 Based on the local climate condition, construction features and insulation level, calculate the required cooling(heating) capacity per square meter.

2.2 Conclude the total capacity which will be needed by the construction.

2.3 According to the total capacity needed, choose the right model by consulting the heat pump features as below:

Heat pump features

- Cooling only unit: chilled water outlet temp. at $5-15^{\circ}\text{C}$, maximum ambient temp. at 43°C . Heating and Cooling unit: for cooling chilled water outlet temp. at $5-15^{\circ}\text{C}$, maximum ambient temp. at 43°C . For heating, warm water inlet temp. at $40-50^{\circ}\text{C}$, minimum ambient temp. at -25°C .

● Unit application

Inverter air source water heat pump is used for house, office, hotel, and so forth, which need heating or cooling separately, with each area need to be controlled.

3 Installation method

The heat pump can be installed onto the concrete basement by expansion screws, or onto a steel frame with rubber feet which can be placed on the ground or housetop. Make sure that the unit is placed horizontally.

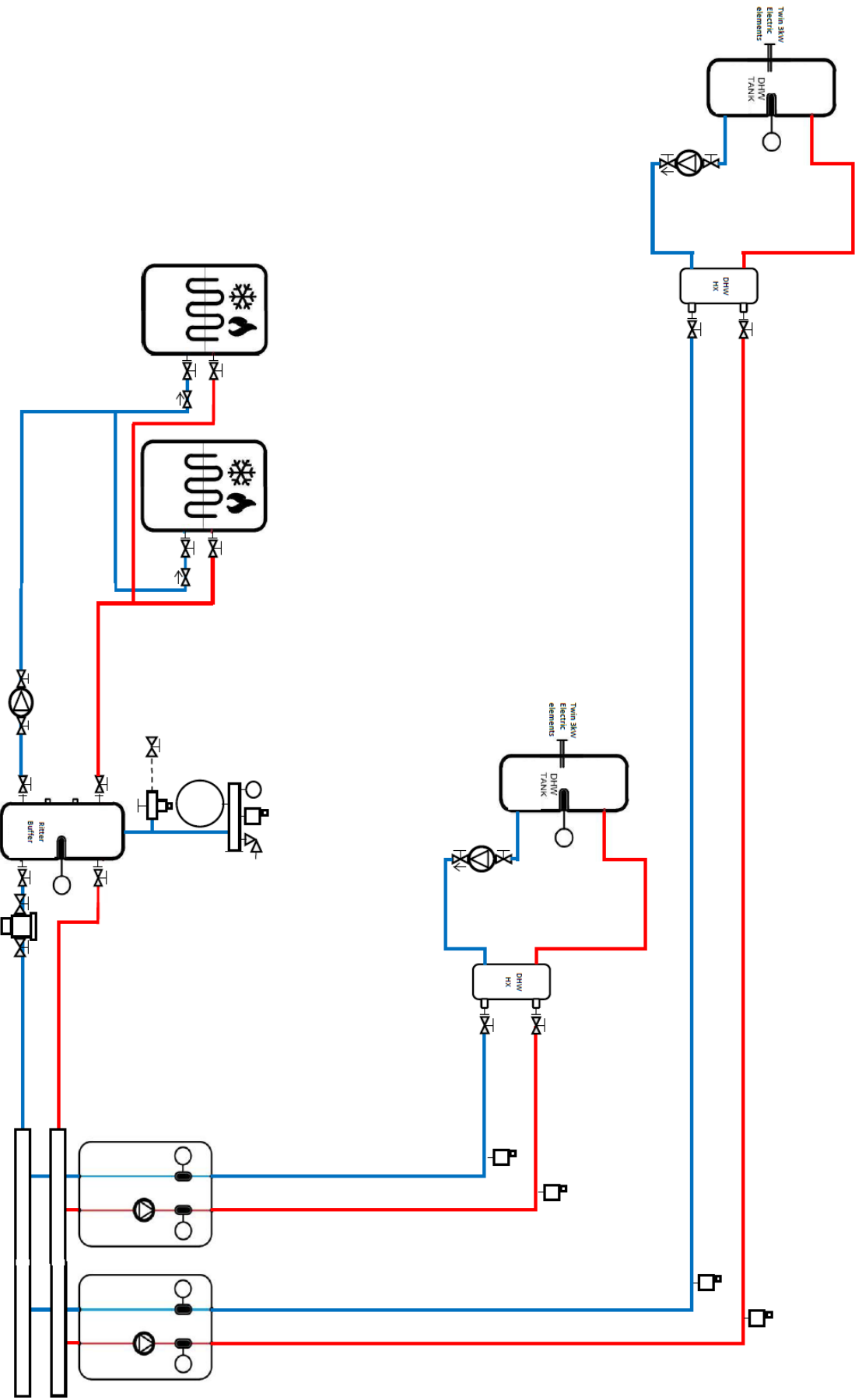

Project name		Sample system	
Design number	PCD1735-559	HP to mains: 50mm crimp copper	Key
Design engineer	0	Mains to buffer: 50mm crimp copper	Union isolator
Heat Source	2x Ritter thermal R290, 50kW	Buffer to pump stations: 50mm crimp copper	Spring check valve
Buffer tank	Ritter buffer tank, 500L	Pump station to HX: 32mm crimp copper	3 way zone valve
DHW	2x Protankplus 2.0, 500L storage tank, 10bar	HX to cylinder: 32mm crimp copper	2 way zone valve
Pressure limiting	Caleffi 535H PRV, high temp, low lead, 40mm		Autofill valve
Thermostatic	Caleffi 5231 thermostatic TV, 25mm		Gauge
UV Sterilizer	Viqua UV purifier, 130 L/m, 20/25mm		Air vent
			Safety valve
			Expansion vessel
			Circulation pump
			By-pass valve
			Mag filter
			Anti-frost valve

4 Installation place

- The unit can be installed on any place outdoor which can carry heavy machine such as terrace, housetop, ground and so on.
- The location must have good ventilation.
- The place is free from heat radiation and other fire flame.
- A pall is needed in winter to protect the heat pump from snow.
- There must be not obstacles near the air inlet and outlet of the heat pump.
- A place which is free from strong air blowing.
- There must be water channel around the heat pump to drain the condensing water .
- There must be enough space around the unit for maintenance.
- A place which is far away operating or potential ignition sources (for example: open flames, an operating gas appliance or an operating electric heater or Electric Spark or hot object)

5 Refrigerant charge

The heat pump is supplied pre-charged with R290 refrigerant.
If the appliance needs to be recharged follow the procedure below.

5.1 Preparations:

- 5.1.1 Please in a well-ventilated environment while charge refrigerant.
- 5.1.2 Keep away from open flames or potential sources of fire.
- 5.1.3 Disconnect the power supply of the heat pump.
- 5.1.4 Carefully check the nameplate of the heat pump and charge strictly according to the labeled amount.

5.2. Check the pressure of nitrogen gas inside the system. The heat pump has charged about 30 Bar pressure nitrogen gas inside the system, please check whether there is still high-pressure nitrogen before charging refrigerant, otherwise check the leakage point. (Use spanner remove the seal nut 1 and 3 , use 5mm inner hexagon spanner open the valve 2. If it can Blowing out the high-pressure gas then the heat pump is not leaking.)

5.3. Use 5mm inner hexagon spanner open the valve 2 and release all the nitrogen gas inside the system.

5.4. Vacuumize the heat pump. Connect the vacuume pump with the valve 2, keep vacuume pump running until the absolute pressure below 30Pa or operating time more than one hour.

5.5. Charge refrigerant. Keep the refrigerant in liquid state when charging and strictly according to the labeled amount.

5.6. Finish the charging, close the valve 2 and screw the seal nut 1 and 3.

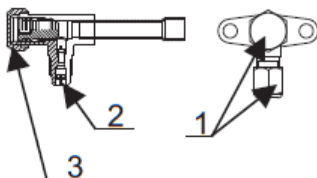
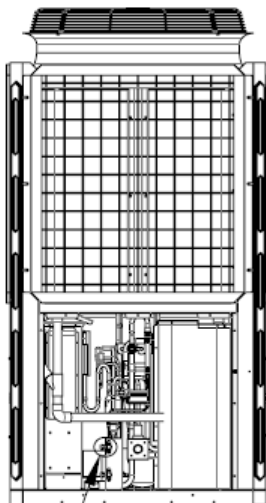

Stop valve signs:
Low pressure

Installation

6 Water loop connection

Please pay attention to below matters when the water pipe is connected:

- Try to reduce the resistance to the water from the piping.
- The piping must be clear and free from dirty and blocks. Water leakage test must be carried out to ensure there is no water leaking. And then the insulation can be made.
- Attention that the pipe must be tested by pressure separately. DO NOT test it together with the heat pump.
- There must be expansion tank on the top point of the water loop, and the water level in the tank must be at least 0.5 meter higher than the top point of the water loop.
- The flow switch is installed inside of the heat pump, check to ensure that the wiring and action of the switch is normal and controlled by the controller.
- Try to avoid air stayed inside of the water pipe, and there must be air vent on the top point of the water loop.
- There must be thermometer and pressure meter at the water inlet and outlet, for easy inspection during running.

7 Power supply connection

- Open the front panel, and open the power supply access.
- The power supply must go through the wire access and be connected to the power supply terminals in the controlling box. Then connect the 3-signal wire plugs of the wire controller and main controller.
- If the outside water pump is needed, please insert the power supply wire into the wire access also and connect to the water pump terminals.
- If an additional auxiliary heater is need to be controlled by the heat pump controller, the relay (or power) of the aux-heater must be connected to the relevant output of the controller.

8 Location of the unit

The unit can be installed separately or in multiple. When multiple units are installed in combination, attention should be paid to their arrangement.

Installation space for single unit: (unit: mm)

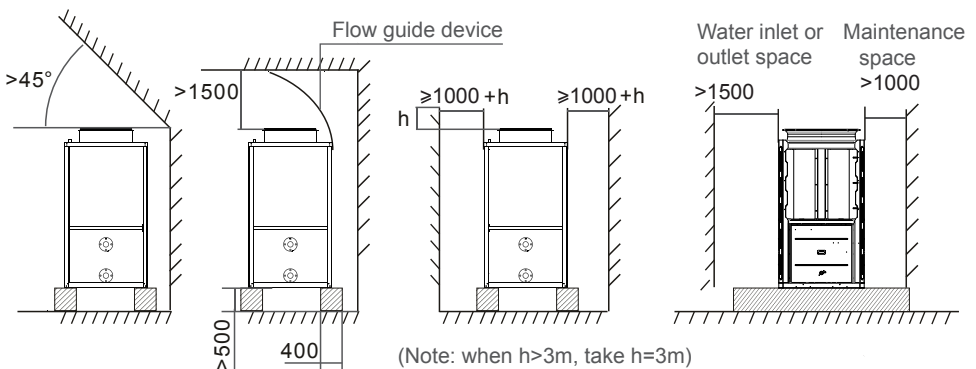

Installation

Installation space for multiple units (same pipe length): (unit: mm)

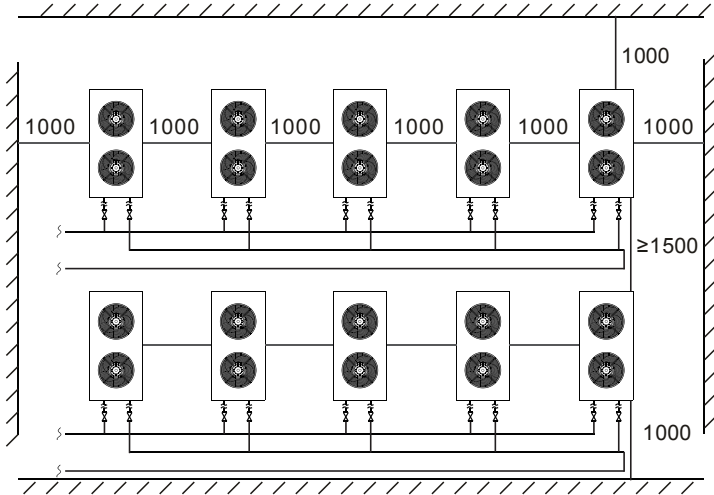

- Note:
- Do not cover the air outlet of the unit;
 - If there is a barrier above the unit, please keep it 3000mm above the unit;
 - If there are objects stacked around the unit, its height should be at least 400mm lower than the top of the unit;
 - When installed in a small room, certain measures should be taken to prevent the leakage of refrigerant. Once leakage volume exceeds the limit concentration, it may cause suffocation. Please consult your dealer for specific measures.

9 Transit

When the heat pump is transported please keep the unit stand up. The unit cannot be laid down, otherwise the inner parts of the device may be damaged.

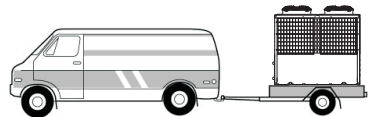

Installation

When the unit need to be hung up during installation, a 8 meters cable is needed, and there must be soft material between the cable and the unit to prevent damage to the heat pump cabinet. (See picture 1)

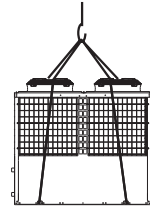

Picture 1

Or please use forklift, since there is wood chassis as package.

 WARNING	DO NOT touch the heat exchanger of the heat pump with fingers or other objects!
---	--

10 Trial Running

Inspection before trial running

- Check the indoor unit, and make sure that the pipe connection is right and the relevant valves are open .
- Check the water loop, to ensure that the water inside of the expansion tank is enough, the water supply is good, the water loop is full of water and without any air. Also make sure there is good insulation for the water pipe.
- Check the electrical wiring. Make sure that the power voltage is normal, the screws are fastened, the wiring is made in line with the diagram, and the earthing is connected.
- Check the heat pump unit including all of the screws and parts of the heat pump to see if they are in good order. When power on, review the indicator on the controller to see if there is any failure indication. The gas gauge can be connected to the check valve to see the high pressure(or low pressure) of the system during trial running.

Trial running

- Start the heat pump by press "⏻" key on the controller. Check whether the water pump is running, if it runs normally there will be 0.2 MPa on the water pressure meter.
- When the water pump runs for 1 minutes, the compressor will start. Hear whether there is strange sound from the compressor. If abnormal sound occurs please stop the unit and check the compressor. If the compressor runs well please look for the pressure meter of the refrigerant.
- Then check whether the power input and running current is in line with the manual. If not please stop and check.
- Adjust the valves on the water loop, to make sure that the hot(cool) water supply to each door is good and meet the requirement of heating(or cooling).
- Review whether the outlet water temperature is stable.
- The parameters of the controller are set by the factory, it is not allowed to change then by user himself.

Operation and Use

5.1.Main interface display and function

(1) Electricity Interface

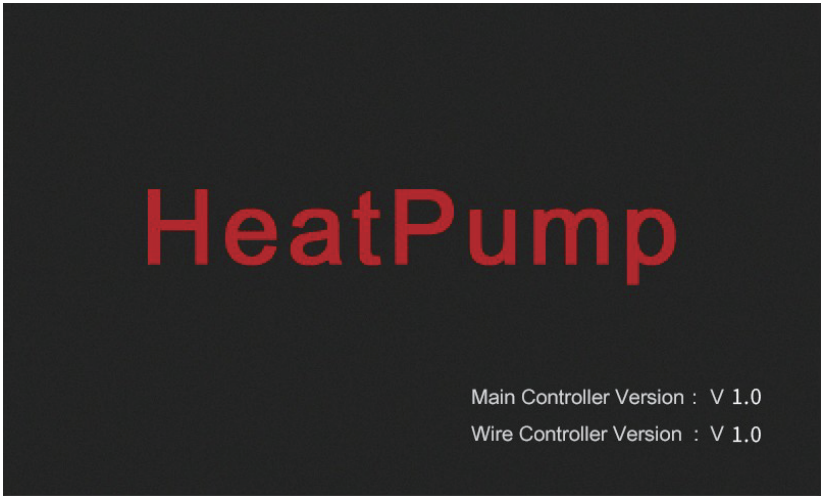

Fig.1 Electricity interface

(2) Main interface of power-off interface

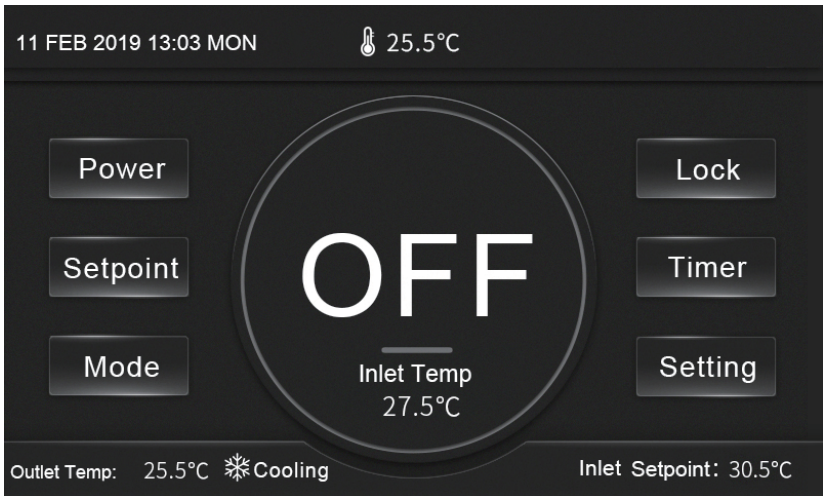

Fig.2 Power-off interface

Operation and Use

(3) Main interface of power-on

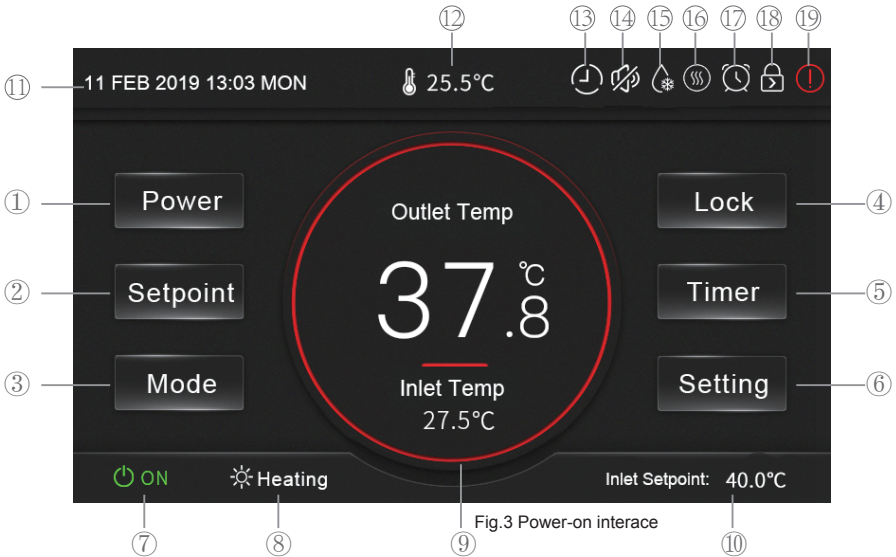

Fig.3 Power-on interface









Button function

No.	Name	Function
①	Power	Press to switch ON or OFF
②	Setpoint	Press to set the target temperature
③	Mode	Press to select cooling or heating mode
④	Lock	Press to lock or unlock screen
⑤	Timer	Press to enter timer setting interface (Temp Timer, Power Timer, Mute Timer)
⑥	Setting	Press to enter function setting interface (Status, Parameter, Failure, Time)

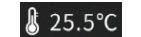
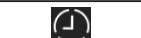
Running status icons description

No.	Icon	Description
⑦		Indicating that the unit is power-on
⑧	 	Indicating the operating mode: Heating or Cooling

Operation and Use

No.	Icon	Description
⑨	Display circle	Indicating the operating status: blue--cooling mode; red-heating mode; grey-power-off mode.
⑩		Indicating the target temperature of inlet water
⑪		Indicating the date and time
⑫		Indicating the ambient temperature
⑬		Indicating the Temp Timer function is activated
⑭		Indicating that the mute mode is activated
⑮		Indicating that the defrost mode is activated
⑯		Indicating that the electric auxiliary heating mode is activated
⑰		Indicating that the power timer mode is activated
⑱		Indicating the lock screen status
⑲		Failure alarm icon. Indicating that while the failure occurs, the icon blinks; after the failure is removed, the icon is no longer displayed

5.2 Instructions for operation of wire controller

(1) Power on/ off

In the main interface, press “Power” button ① to power on/ off the unit.



(2) Mode selection

In the main interface, press “Mode” button ③ to select cooling or heating mode. And then status bar ⑧ will display the current operating state. While in the main interface of power-on (Fig. 2), the display circle ⑨ colour will be changed according to the operating state (cooling: blue; heating: red).

(3) Target temperature setting

To adjust the target temperature value, firstly select the running mode (cooling or heating), press “Setpoint” button ② to jump to the parameter setting interface, then enter the required parameter according to the effective range which is displayed at the bottom of the screen.

(4) Lock screen function

In the main interface, press “Lock” button to activate the lock screen function, status icon  ⑱ will light; press “Lock” button again and enter the password 22 to unlock the screen and the status icon  will not be displayed.

Operation and Use

(5) Timer setting

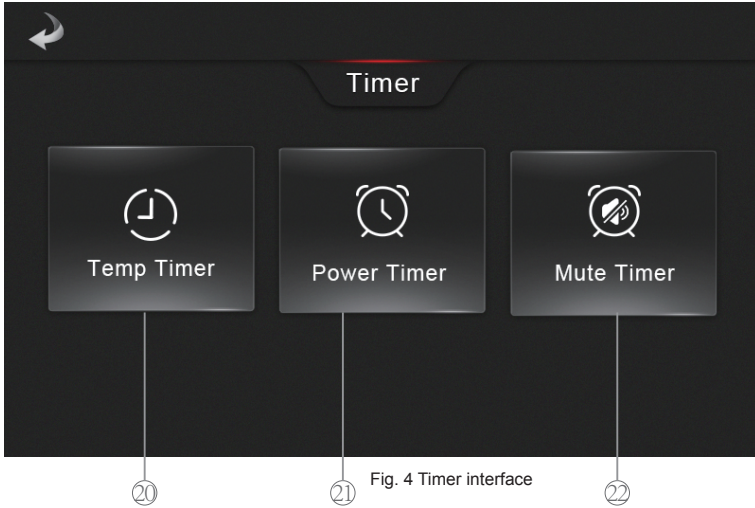

Fig. 4 Timer interface

Button function

No.	Name	Function
⑳	Temp Timer	Press to jump to the time-sharing temperature control setting interface
㉑	Power Timer	Press to jump to the timing switch setting interface
㉒	Mute Timer	Press to jump to the Mute Timer interface

- Temp Timer

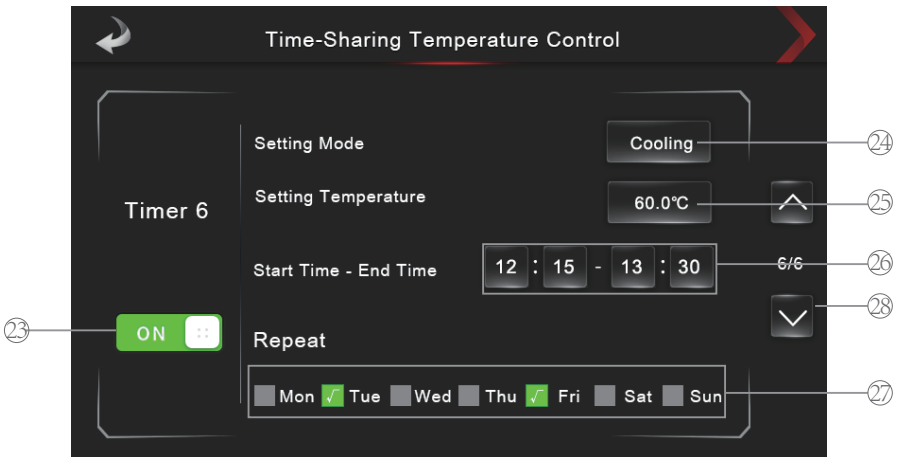

Fig. 5 Temp timer interface

Operation and Use

No.	Name	Function
23	Enable key	Click whether to enable time-sharing temperature control in this section, the icon for opening is green and the icon for closing is grey.
24	Mode setting	Set the mode for the time-sharing temperature control
25	Temperature setting	Set the target temperature for the time-sharing temperature control
26	Time setting	Set the time for the time-sharing temperature control
27	Week setting	Set the week for the time-sharing temperature control
28	Turn the page	Turn the page to enter other time-sharing temperature control interface

- Power Timer

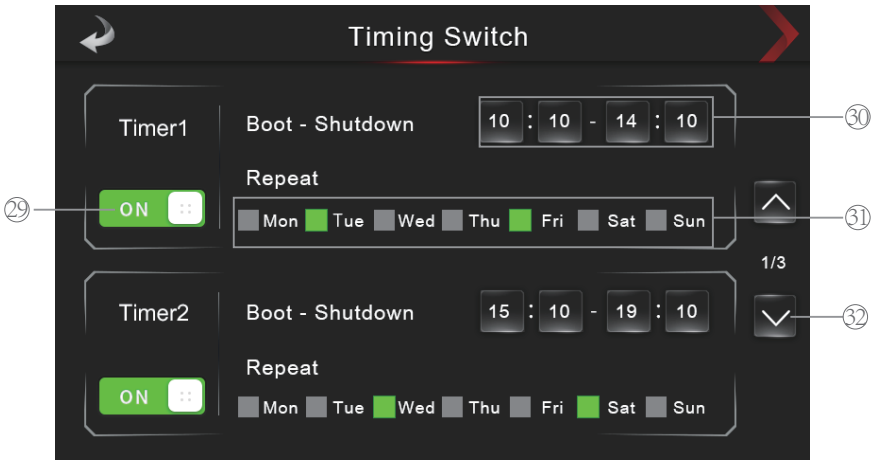

Fig. 6 Power timer interface

No.	Name	Function
29	Enable key	Click whether to enable timing switch in this section, the icon for opening is green and the icon for closing is grey.
30	Time setting	Set the time for the timing switch
31	Week setting	Set the week for the timing switch
32	Turn the page	Turn the page to enter other timing switch interface

- Mute Timer

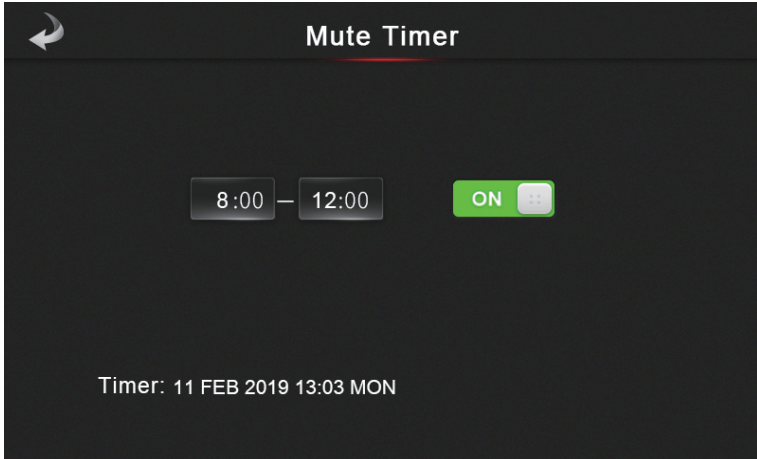



Fig. 7 Mute timer interface

To enable Mute Timer function, firstly press Timer button ⑤ in the main interface, secondly press Mute Timer button ② (Fig.4), it jumps to Mute Timer interface, enter the start and end timer, and lastly press on/off button to enable or disable the setting. When the Mute Timer function is enable, the main interface displays “”.

Note: green: enable; grey: not enable.

If the unit without Mute Timer function, the operation is not available.

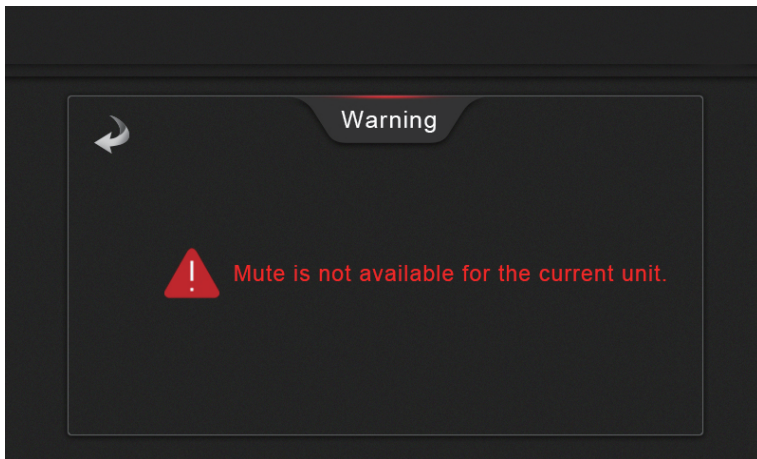

Fig. 8 Warning interface

(6) Setting function

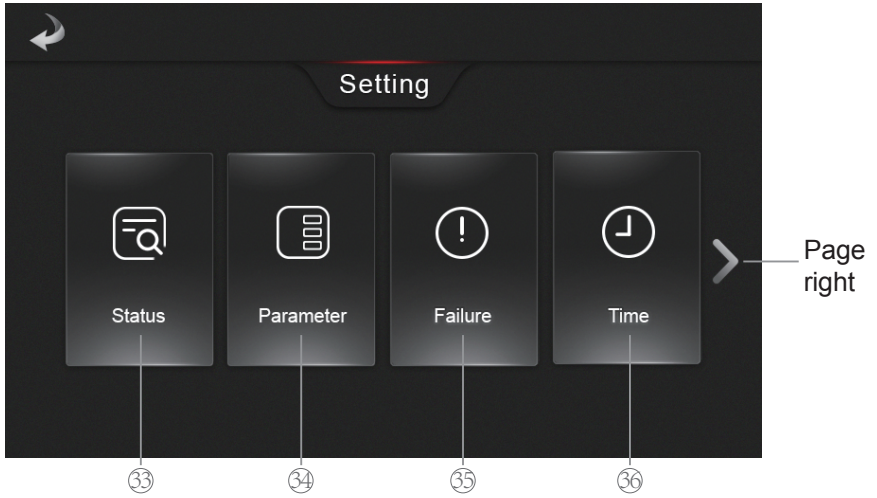

Fig. 9 Setting interface

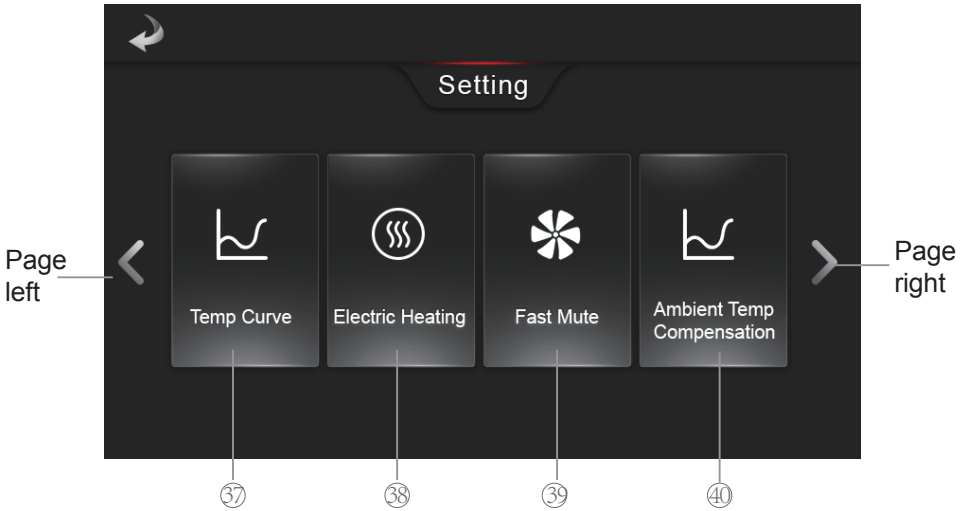

Fig. 10 Setting interface

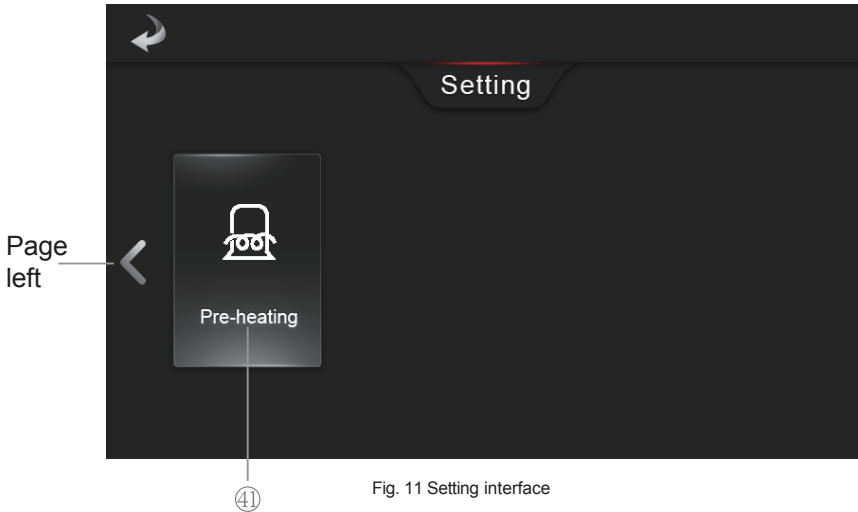

Fig. 11 Setting interface

Button function

No.	Name	Function
33	Status	Press to jump to the status inquiry interface to inquire the running and unit status parameter
34	Parameter	Press and enter password "22" to inquire installer parameter
35	Failure	Press to inquire failure record
36	Time	Press to jump to the Time Setting interface and adjust system time parameter
37	Temp Curve	Press to inquire the temperature curve
38	Electric Heating	Press to turn on/off the electric heating mode
39	Fast Mute	Press to turn on/off fast mute mode
40	Ambient Temp Compensation	Press to jump to the weather compensation setting interface
41	Pre-heating	Press to jump to the electric auxiliary heating menu and turn on the electric auxiliary heating function

Operation and Use

- **Setting interface**
In the main interface, press Setting button ⑥ to jump to Setting interface (Fig.9).
- **Status inquiry function**
In the Setting interface (Fig.9), press Status button 33 to jump to Status interface.

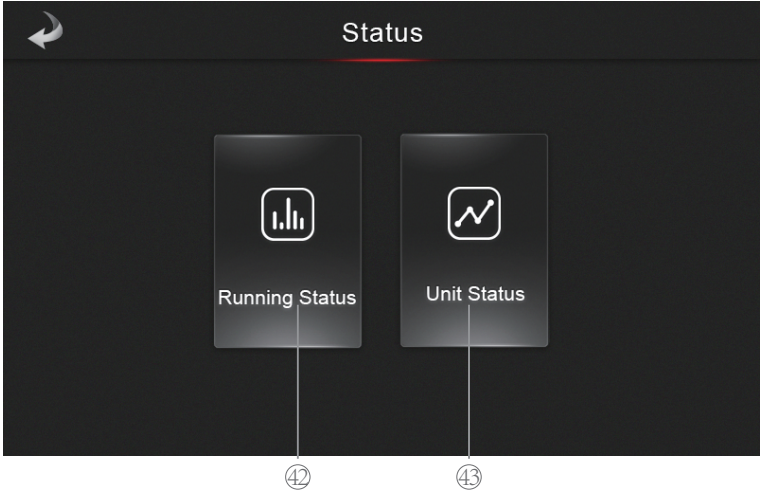

Fig.12 Status interface

Running Status inquiry function

In the Status interface, press Running Status button ④② to inquire the running status parameter (Fig.13-1).

Unit Status inquiry function

In the Status interface, press Unit Status button ④③ to inquire the unit status parameter, press **Load**, **Switch**, **Temp**, **Unit Info** OR **Inverter** to inquire the relevant parameters (Fig.13-2).

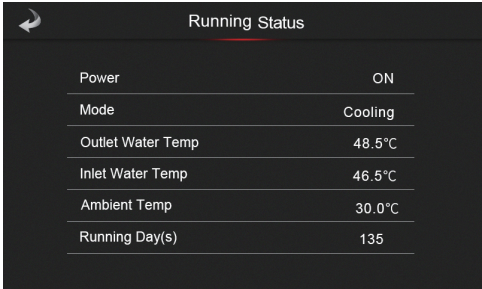

Fig.13-1 Running Status interface

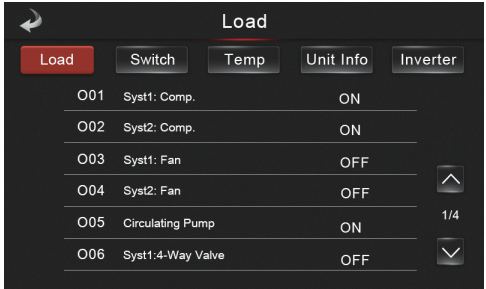



Fig.13-2 Unit Status interface

Operation and Use

- Failure record inquiry function

While failure occurs, the icon  is flashing in the main interface. In the Setting interface (Fig.9), press Failure button  to jump to Failure Record interface for inquiring the current failure records (Fig.14).

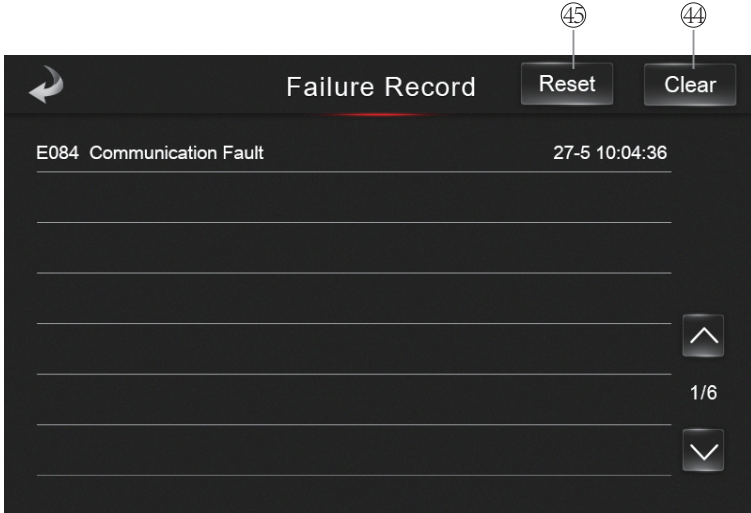



Fig.14 Failure Record interface

1) After the failure is solved:

(1) The failure code, failure name and occurrence time recorded on the failure interface will still be saved;

(2) Click  to clear the failure record. The solved failure will not appear in the failure record.

2) The failure record has the power failure memory function, but if the record is manually cleared, the record will not appear again.

3) In the Failure Record interface (Fig.14), press  to enter delete all the history failure records interface (Fig.15-1). Ordinary solution see 5.3.

4) In the Failure Record interface (Fig.14), press  to enter recovery the failure three times to lock interface (Fig.15-2).

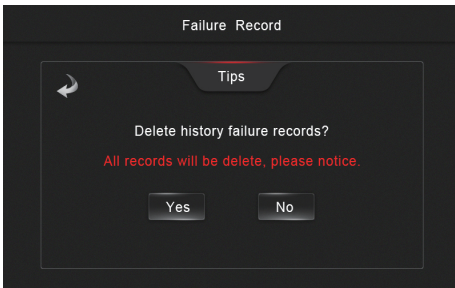

Fig.15-1 Delete history failure interface

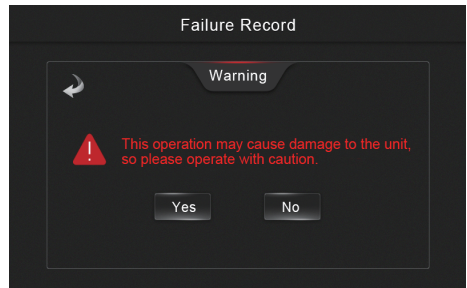

Fig.15-2 Recovery the failure three times to lock interface

Operation and Use

- System time setting

In the Setting interface (Fig.9), press Time button ③⑥ to jump to Time Setting interface (Fig.16), click on the input field and enter time digital, press **Save** to save the settings.

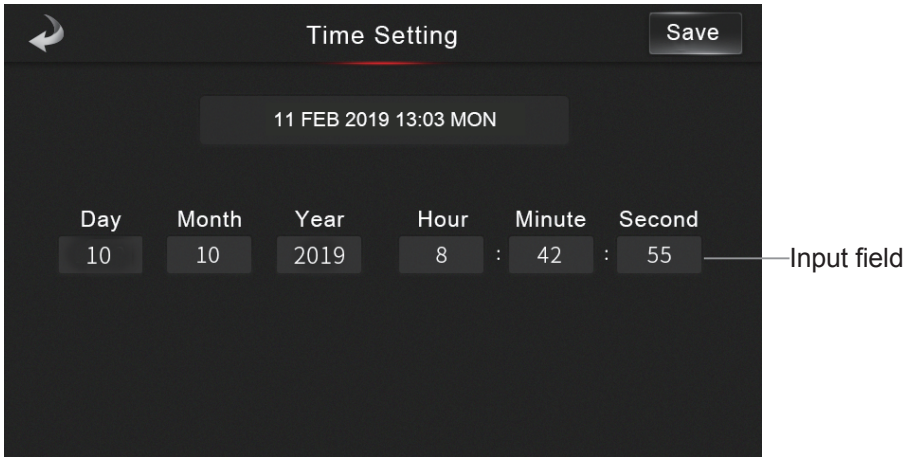

Fig.16 Time Setting interface

- Temp Curve inquiry function

In the Setting interface (Fig.10), press Temp Curve button ③⑦ to inquire the inlet/outlet/ambient temperature curve interface (Fig.17).

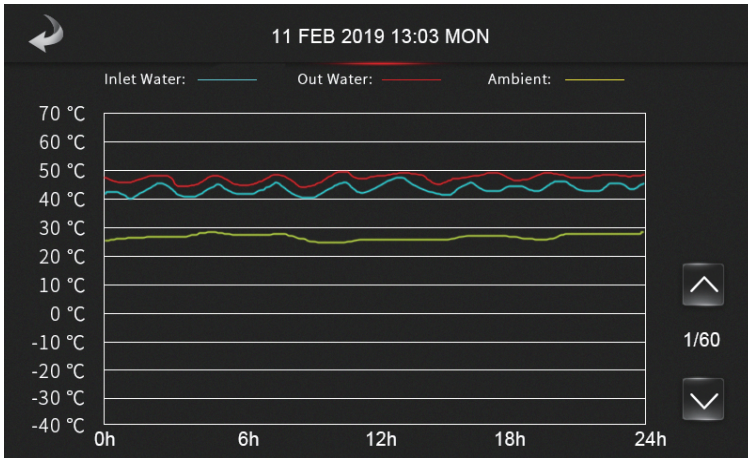



Fig.17 Temperature Curve interface

Operation and Use

- a) This curve function records the water inlet temperature, water outlet temperature and ambient temperature;
- b) Temperature data is collected every 5 minutes and the 12 sets of temperature data are saved every hour. Timekeeping is made from the latest data saving, if the power is disrupted when the time is less than 1 hour (12 sets), the data during such period will not be saved.
- c) Only curve for electricity status is recorded, and that for outage status will not be saved;
- d) The value of the abscissa indicates the time from the point on the curve to the current time point. The leftmost point on the first page (0 on the abscissa) is the latest temperature record;
- e) Temperature curve record is provided with power off memory function.

In case of disturbed curve recording and display, after the next power on, the wire controller will automatically clear the history curve record and the curve recording function will restore to a normal state.

- Electric Heating function

In the Setting interface (Fig.10), while the button  displays "OFF Electric Heating", firstly make sure the unit is operated in heating mode, then press Electric Heating button  to jump to Electric Heating interface (Fig.18-1), click the button to be ON, the electric auxiliary heating mode is activated; while the unit is in running in electric auxiliary heating mode, turn off the electric heating function by the same operation steps.

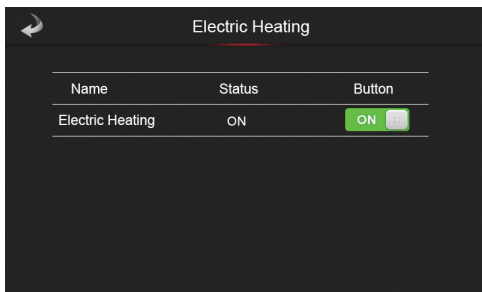

Fig.18-1 Electric Heating interface

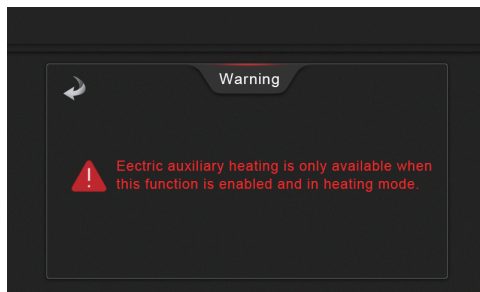

Fig.18-2 Warning interface

Note: Electric auxiliary heating is only available when this function is enable and in heating mode.

Operation and Use

- Fast Mute function

In the Setting interface (Fig.10), while the button ③⁹ displays “OFF Fast Mute” and “❌”, press this button ③⁹ to enable fast mute function and it displays “ON Fast Mute” and “🔇”; while the fast mute mode is enable, press this button again to turn off it. Fast Mute is only available when this function is enable, or the fast mute function cannot be set.

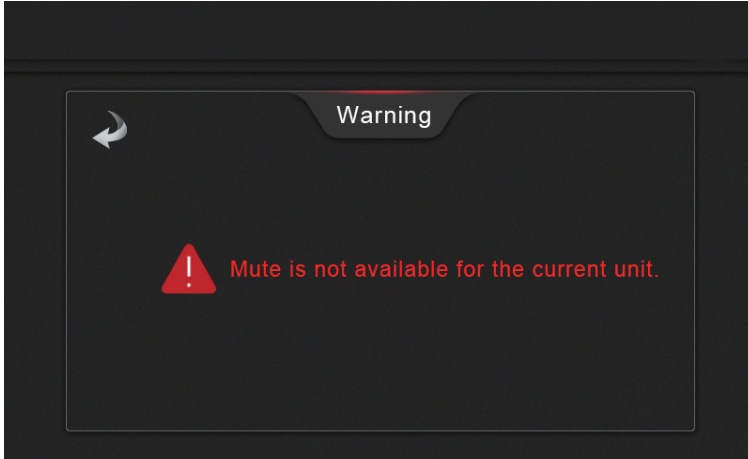

Fig. 19 Warning interface

- Ambient Temp Compensation function

In the Setting interface (Fig.10), press Ambient Temp Compensation button ④⁰ to jump to Weather Compensation interface. Click the Slope button ④⁶ and the Offset button ④⁷ to set the parameter.

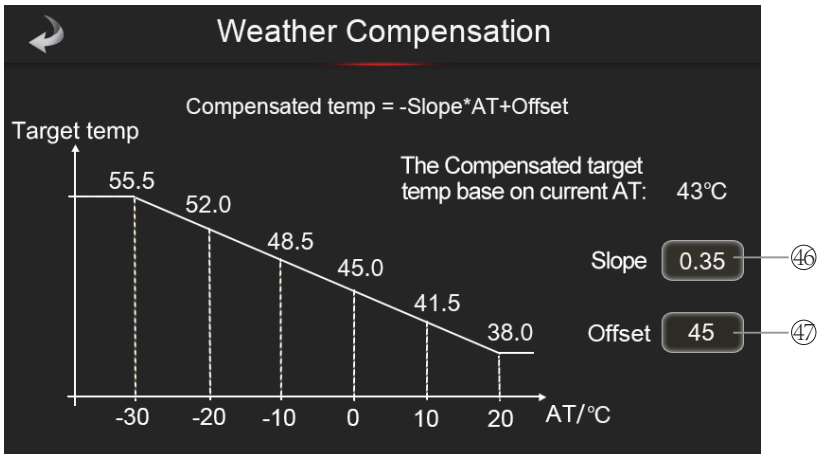

Fig. 20 Weather Compensation interface

Note: When disable the Ambient Temp Compensation function, the target temp display “----”.

- Pre-heating function



In the Setting interface (Fig.11), while the button ④ displays “OFF Pre-heating” and “A screenshot of a warning interface on a dark background. At the top center, the word "Warning" is displayed in white. Below it, a red triangle with a white exclamation mark is shown to the left of the text "Pre-heating function is only available when the unit is switched off." in red. In the top-left corner of the warning box, there is a white curved arrow pointing left.

Fig.21 Warning Interface

5.3 Electronic control failure code and troubleshooting table

Failure code and troubleshooting table

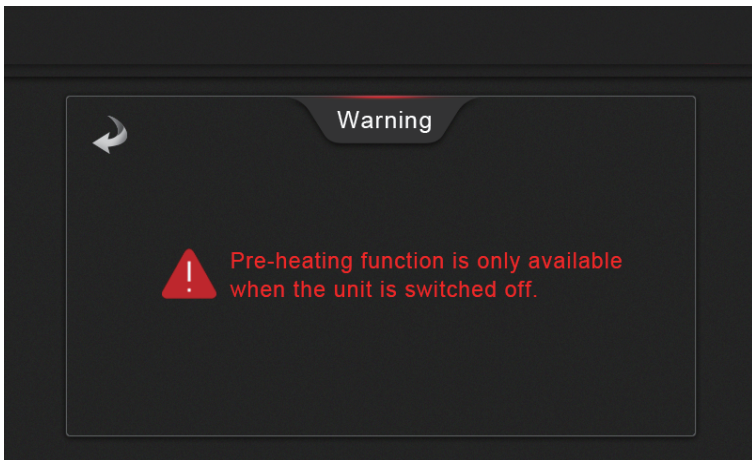
Protection/failure	Codes	Causes	Removal methods
Communication Fault	E08	Abnormal communication between wire controller and the main board	Inspect whether the wire controller, the main board and the connection thereof are reliable
The Wire Controller Does Not Match The Mainboard	E084	The mainboard software code is inconsistent with the setting	Normal operation, not affected
DC Fan Board 1 Communication Fault	E081	Communication of the speed regulation module 1 with main board is abnormal	Check the speed regulation module 1 and the main board and if their connections are normal and reliable
Syst1: High Pressure Prot.	E11	The high-voltage switch of the system is disconnected	Inspect System 1 voltage switch and refrigerating circuit for any failure
Syst2: High Pressure Prot.	E21	The high-voltage switch of the system is disconnected	Inspect System 2 voltage switch and refrigerating circuit for any failure
Syst1: Low Pressure Prot.	E12	The low-voltage switch of the system is disconnected	Inspect System 1 voltage switch and refrigerating circuit for any failure
Syst2: Low Pressure Prot.	E22	The low-voltage switch of the system is disconnected	Inspect System 2 voltage switch and refrigerating circuit for any failure
Water Flow Switch Prot.	E032	The water system has no or only few water	Inspect whether the water flow of the water pipe conforms to related requirements and check the water pump for any damages
Electric Heater Overload Prot.	E04	Electric heating overheat protection switch is disconnected	Inspect whether the electric heating is under operation condition of over 150 °C for a long time
Primary Antifreezing Prot. In Winter	E19	Excessively low environment temperature	The environment temperature is more than 4 °C
Secondary Antifreezing Prot. in Winter	E29	Excessively low environment temperature	The environment temperature is more than 4 °C
Syst1: Antifreezing Prot.	E171	The water flow of the system is insufficient	Inspect whether the water flow of the water pipe conforms to related requirements and check the water pump for any blockage
Syst2: Antifreezing Prot.	E271	The water flow of the system is insufficient	Inspect whether the water flow of the water pipe conforms to related requirements and check the water pump for any blockage
Water(Out) High Temp Prot.	E065	Excessively high water outlet temperature	Adjust the outlet water temperature < A07-10 °C
Fan 1 Thermal Overload Prot.	E103	Fan 1 thermal overload	Check if fan 1 is running normally
Fan 2 Thermal Overload Prot.	E203	Fan 2 thermal overload	Check if fan 2 is running normally
Syst1: Exhaust Air High Temp Prot.	P182	The system compressor is overloaded	Inspect whether the operation of System 1 compressor is normal
Syst2: Exhaust Air High Temp Prot.	P282	The system compressor is overloaded	Inspect whether the operation of System 2 compressor is normal
Water In/Out Large Temp Diff Prot.	E06	The water flow of the system is insufficient, the pressure difference of the water system is small	Inspect whether the water flow of the water pipe conforms to related requirements and check the water pump for any blockage
Water(Out) Low Temp Prot.	E071	Excessively low water outlet temperature	Adjust the outlet water temperature ≥8 °C
Low Water Flow Prot.	E035	The system has no water or too low volume of water	Check if the water flow of water pipe meets the requirements and if the water pump is damaged.
Syst1: 4-Way Valve Abnormal Switch	E121	The system 4-way valve switching failure	Check if the state of the 4-way valve switching direction is the desired state
Syst2: 4-Way Valve Abnormal Switch	E221	The system 4-way valve switching failure	Check if the state of the 4-way valve switching direction is the desired state
Water In Sensor Fault	P01	The temperature sensor is open or short circuited	Check and replace inlet water temperature sensor
Water Out Sensor Fault	P02	The temperature sensor is open or short circuited	Check and replace outlet water temperature sensor

Operation and Use

Protection/fault	Codes	Causes	Removal methods
Syst1: Coil Temp Sensor1 Fault	P150	The temperature sensor is open or short circuited	Check and replace the system 1 coil 1 temperature sensor
AT Sensor Fault	P04	The temperature sensor is open or short circuited	Check and replace the ambient temperature sensor
Syst1: Suction Temp Sensor Fault	P17	The temperature sensor is open or short circuited	Check and replace the system 1 return air temperature sensor
Syst1: Antifreezing 1 Sensor Fault	P191	The temperature sensor is open or short circuited	Check and replace the system 1 use side antifreeze 1 temperature sensor
Syst2:Coil Temp Sensor1 Fault	P250	The temperature sensor is open or short circuited	Check and replace the system 2 coil 1 temperature sensor
Syst1: Coil(Out) Temp Sensor Fault	P152	The temperature sensor is open or short circuited	Check and replace the system 1 coil outlet temperature sensor
Syst2: Coil(Out) Temp Sensor Fault	P252	The temperature sensor is open or short circuited	Check and replace the system 2 coil outlet temperature sensor
Syst1: EVI(In) Temp Sensor Fault	P101	The temperature sensor is open or short circuited	Check and replace the system 1 EVI inlet temperature sensor
Syst1: EVI(Out) Temp Sensor Fault	P102	The temperature sensor is open or short circuited	Check and replace the system 1 EVI outlet temperature sensor
Syst1: Exhaust Air Temp Sensor Fault	P181	The temperature sensor is open or short circuited	Check and replace the system 1 exhaust temperature sensor
Syst1: Low Pressure Sensor Fault	PP11	The sensor is open or short circuited	Check and replace the system 1 low pressure sensor
Syst2: Suction Temp Sensor Fault	P27	The temperature sensor is open or short circuited	Check and replace the system 2 return air temperature sensor
Syst2: Antifreezing 1 Sensor Fault	P291	Temperature sensor fault	Check if the temperature sensor is working properly
Syst1: High Pressure Sensor Fault	PP12	The sensor is open or short circuited	Check and replace the system 1 high pressure sensor
Syst2: High Pressure Sensor Fault	PP22	The sensor is open or short circuited	Check and replace the system 2 high pressure sensor
Syst2: Exhaust Air Temp Sensor Fault	P281	Open circuit or short circuit of the temperature sensor	Inspect and replace System 2 exhaust temperature sensor
Syst2: Low Pressure Sensor Fault	PP21	Open circuit or short circuit of the sensor	Inspect and replace System 2 low-voltage sensor
Syst2: EVI(In) Temp Sensor Fault	P201	Open circuit or short circuit of the temperature sensor	Inspect and replace System 2 EVI inlet temperature sensor
Syst2: EVI(Out) Temp Sensor Fault	P202	Open circuit or short circuit of the temperature sensor	Inspect and replace System 2 EVI outlet temperature sensor
Low AT Power-Off Prot.	TP	Excessively low ambient temperature	Adjust the ambient temperature
Syst1: Coil Temp Sensor2 Fault	P154	The temperature sensor is open or short circuited	Check and replace the system 1 coil 2 temperature sensor
DC Fan Board 2 Communication Fault	E082	Communication of the speed regulation module 2 with main board is abnormal	Check the speed regulation module 2 and the main board and if their connections are normal and reliable.
Syst2: Coil Temp Sensor2 Fault	P254	The temperature sensor is open or short circuited	Check and replace the system 2 coil 2 temperature sensor
Syst1: The Inverter Board Communication Fault	F151	Communication failure with system 1 inverter board	1. Check if the communication line is normal; 2. Check if the system 1 inverter board is normal
Syst1: Comp. Start Fault	F152	System 1 compressor failed to start	1. Check if the compressor line is normal; 2. Check if the system 1 compressor is blocked
Syst1: Comp. Start IPM Prot.	F153	System 1 compressor starting current is too large	1. Check if the starting high pressure is excessive; 2. Check if the system 1 compressor is blocked
Syst1:Comp. Running IPM Prot.	F154	System 1 compressor running current is too large	Check if the pressure ratio is too high
Syst1: Comp. Overcurrent Prot.	F156	System 1 compressor running current is too large	Check if the pressure ratio is too high
Syst1.The Inverter Board IPM Over-Temp. Prot.	F155	System 1 compressor drive board has poor heat dissipation	Check if there is a gap in the installation of the fluorine-cooled heat sink
Syst1:The Inverter Board Bus Over Voltage Prot.	F157	Voltage is too high	Check if the input voltage is higher than 480V

Operation and Use

Protection/fault	Codes	Causes	Removal methods
Syst1:The Inverter Board Bus Under Voltage Prot.	F158	Voltage is too low	Check if the input voltage is lower than 250V
Syst2: The Inverter Board Communication Fault	F251	Communication failure with system 2 inverter board	1. Check if the communication line is normal; 2. Check if the system 2 inverter board is normal
Syst2: Comp. Start Fault	F252	System 2 compressor failed to start	1. Check if the compressor line is normal; 2. Check if the system 2 compressor is blocked
Syst2: Comp. Start IPM Prot.	F253	System 2 compressor starting current is too large	1. Check if the starting high pressure is excessive; 2. Check if the system 2 compressor is blocked
Syst2: Comp. Running IPM Prot.	F254	System 2 compressor running current is too large	Check if the pressure ratio is too high
Syst2: Comp. Overcurrent Prot.	F256	System 2 compressor running current is too large	Check if the pressure ratio is too high
Syst2:The Inverter Board IPM Over-Temp Prot.	F255	System 2 inverter board has poor heat dissipation	Check if there is a gap in the installation of the fluorine-cooled heat sink
Syst2:The Inverter Board Bus Over Voltage Prot.	F257	Voltage is too high	Check if the input voltage is higher than 480V
Syst2:The Inverter Board Bus Under Voltage Prot.	F258	Voltage is too low	Check if the input voltage is lower than 250V
DC Fan 1 Phase Loss Prot.	F101	System 1 fan failed to start	Check if the system 1 fan line is normal
DC Fan 1 Zero Speed Prot.	F102	System 1 fan failed to start	Check if the system 1 fan rotor is locked
DC Fan 1 Start IPM Prot.	F103	System 1 fan starting current is too large	Check if the system 1 fan rotor is locked
DC Fan 1 Running IPM Prot.	F104	System 1 fan running current is too large	Check if the system 1 fan rotor is locked
DC Fan 1 Overcurrent Prot.	F105	System 1 fan running current is too large	Check if the system 1 fan rotor is locked
DC Fan 1 Over-Temp Prot.	F106	System 1 fan drive board has poor heat dissipation	Check the heat dissipation condition
DC Fan 1 Bus Over Voltage Prot.	F107	Voltage is too high	Check if the input voltage is higher than 480V
DC Fan 1 Bus Under Voltage Prot.	F108	Voltage is too low	Check if the input voltage is lower than 250V
DC Fan 2 Output Phase Loss Prot.	F201	System 2 fan failed to start	Check if the system 2 fan line is normal
DC Fan 2 Output Zero Speed Prot.	F202	System 2 fan failed to start	Check if the system 2 fan rotor is locked
DC Fan 2 Start IPM Prot.	F203	System 2 fan starting current is too large	Check if the system 2 fan rotor is locked
DC Fan 2 Running IPM Prot.	F204	System 2 fan running current is too large	Check if the system 2 fan rotor is locked
DC Fan 2 Overcurrent Prot.	F205	System 2 fan running current is too large	Check if the system 2 fan rotor is locked
DC Fan 2 Over-Temp Prot.	F206	System 2 fan drive board has poor heat dissipation	Check the heat dissipation condition
DC Fan 2 Bus Over Voltage Prot.	F207	Voltage is too high	Check if the input voltage is higher than 480V
DC Fan 2 Bus Under Voltage Prot.	F208	Voltage is too low	Check if the input voltage is lower than 250V
Abnormal Power Fault	EE1	Power failure occurs on the home interface	The failure is cleared by the main control after 3 minutes
DC Fan Motor 1 Current Sampling Fault	F112	The current sampling of fan 1 is abnormal	Check if the system 1 fan rotor is locked
DC Fan Motor 2 Current Sampling Fault	F212	The current sampling of fan 2 is abnormal	Check if the system 2 fan rotor is locked
DC Fan Motor 1 Overspeed Protection	F109	The fan speed of system 1 is too high	Check if the system 1 fan rotor is locked
DC Fan Motor 2 Overspeed Protection	F209	The fan speed of system 2 is too high	Check if the system 2 fan rotor is locked

Operation and Use

Protection/fault	Codes	Causes	Removal methods
DC Fan Motor 1 Lowspeed Protection	F110	The fan speed of system 1 is incorrect	Check if the system 1 fan rotor is locked
DC Fan Motor 2 Lowspeed Protection	F210	The fan speed of system 2 is incorrect	Check if the system 2 fan rotor is locked
Compressor Type Error	F088	The compressor model is incorrect	Check if the compressor model parameters are consistent with the corresponding model
Low Ambient Temp Not Allow Cooling	TC	Ambient temperature is too low to allow cooling	Check if the ambient temperature sensor is working properly
Inlet and Outlet Water Abnormal Prot.	E064	Current inlet water temp. and outlet water temp. Difference is too large	Check if the inlet and outlet water temperature sensor is working properly

5.4 Interface diagram

(1) Wire control and interface diagram and definition

Sign	Meaning
V	12V (power+)
R	No use
T	No use
A	485A
B	485B
G	GND(power-)

(2) Controller interface diagram and definition

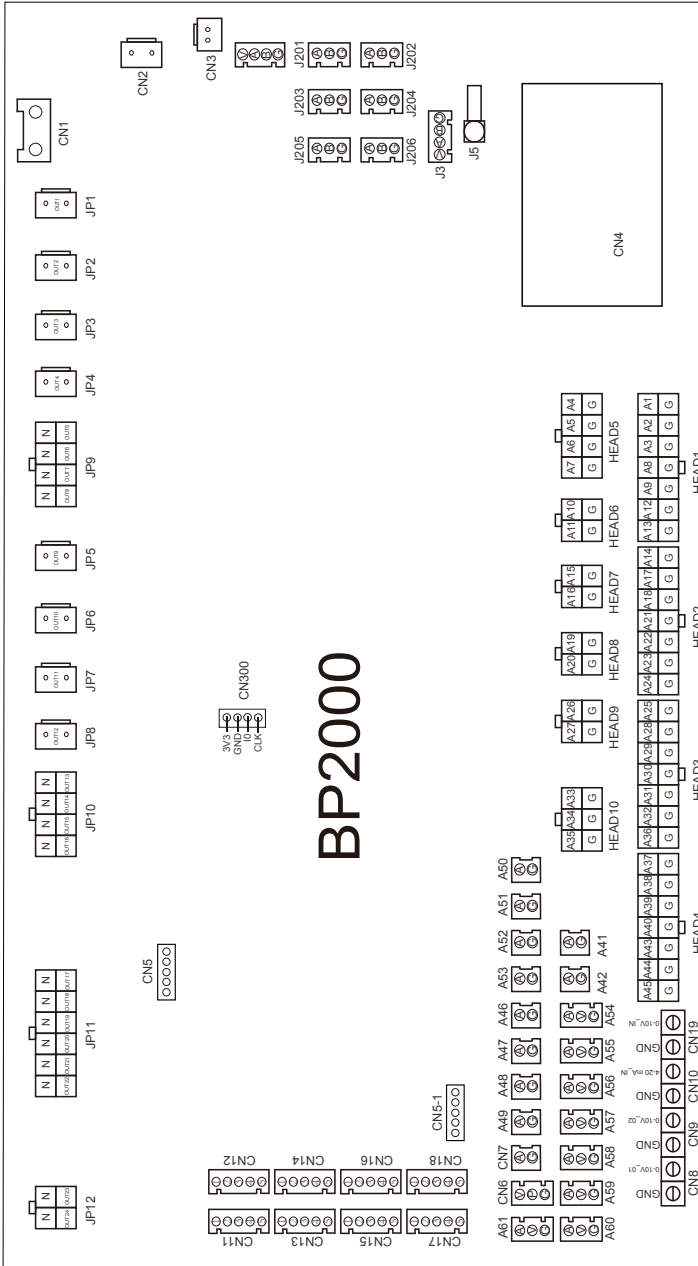

Operation and Use

(3) The input and output interface instructions

No.	Sign	Meaning	No.	Sign	Meaning
1	A1	Syst1: Antifreezing Temp	41	A41	Syst1: Fan Overload Prot.
2	A2	Syst1: Coil Temp 1	42	A42	Syst2: Fan Overload Prot.
3	A3	Syst1: Coil Temp 2	43	A43	Reserved
4	A4	Water Flow Switch	44	A44	Reserved
5	A5	Emergency Input	45	A45	Reserved
6	A6	Mode	46	A46	Reserved
7	A7	Electric Heater Overload Prot.	47	A47	Reserved
8	A8	Syst1: Outlet(Coil) Temp	48	A48	Reserved
9	A9	Syst1: Suction Temp	49	A49	Reserved
10	A10	Syst1: HP Switch	50	A50	Syst1: Exhaust Air Temp
11	A11	Syst1: LP Switch	51	A51	Syst2: Exhaust Air Temp
12	A12	Reserved	52	A52	Reserved
13	A13	Reserved	53	A53	Reserved
14	A14	Syst2: Antifreezing Temp	54	A54	Syst1: High Pressure
15	A15	Syst2: HP Switch	55	A55	Syst2: High Pressure
16	A16	Syst2: LP Switch	56	A56	Reserved
17	A17	Syst2: Coil Temp 1	57	A57	Reserved
18	A18	Syst2: Coil Temp 2	58	A58	Syst1: Low Pressure
19	A19	Reserved	59	A59	Syst2: Low Pressure
20	A20	Reserved	60	A60	Reserved
21	A21	Syst2: Outlet(Coil) Temp	61	A61	Reserved
22	A22	Syst2: Suction Temp	62	CN1	220V input
23	A23	Reserved	63	CN2	220V output
24	A24	Reserved	64	CN3	12V input
25	A25	Reserved	65	CN4	PCle DTU
26	A26	Reserved	66	CN5	Expansion Board
27	A27	Reserved	67	CN6	Reserved
28	A28	Reserved	68	CN7	Reserved
29	A29	Reserved	69	CN8	Reserved
30	A30	Reserved	70	CN9	Reserved
31	A31	Reserved	71	CN10	Reserved
32	A32	Reserved	72	CN11	Syst1: EEV Big Valve
33	A33	Inlet(Water) Temp	73	CN12	Reserved
34	A34	Outlet(Water) Temp	74	CN13	Syst2: EEV Big Valve
35	A35	Ambient Temperature	75	CN14	Syst2: EVI EEV Valve
36	A36	Reserved	76	CN15	Syst1: EVI EEV Valve
37	A37	Reserved	77	CN16	Syst2: EEV Small Valve
38	A38	Reserved	78	CN17	Reserved
39	A39	Reserved	79	CN18	Syst1: EEV Small Valve
40	A40	Reserved	80	CN19	Reserved

Operation and Use

No.	Sign	Meaning	No.	Sign	Meaning
81	CN23	Reserved	98	OUT8	Reserved
82	CN300	Program port	99	OUT9	Syst1:4-Way Valve
83	J1	DTU	100	OUT10	Syst2:4-Way Valve
84	J201	Compressor inverter board 1	101	OUT11	Reserved
85	J202	Compressor inverter board 2	102	OUT12	Reserved
86	J203	DC fan board 1	103	OUT13	Water plate heating belt
87	J204	Reserved	104	OUT14	Reserved
88	J205	Color wire controller	105	OUT15	Reserved
89	J206	Reserved	106	OUT16	Reserved
90	J3	Centralized controller communication port	107	OUT17	Syst1: Fan low speed
91	OUT1	Reserved	108	OUT18	Syst1: Fan high speed
92	OUT2	Reserved	109	OUT19	Syst1: Fan high speed 2
93	OUT3	Reserved	110	OUT20	Syst1: Fan low speed
94	OUT4	Reserved	111	OUT21	Syst1: Fan high speed
95	OUT5	Syst1: Crankshaft Heater	112	OUT22	Syst1: Fan high speed 2
96	OUT6	Syst2: Crankshaft Heater	113	OUT23	Circulating Pump
97	OUT7	Reserved	114	OUT24	Electric Heater

6. Appendix 1、 Caution & Warning

1. The unit can only be repaired by qualified installer centre personnel or an authorised dealer. (for Europe market)
2. This appliance is not intended for use by persons (including children) with reduced physical sensory or mental capabilities, or lack of experience and knowledge, unless they have been given supervision or instruction concerning use of the appliance by a person responsible for their safety. (for Europe market)
Children should be supervised to ensure that they do not play with the appliance.
3. Please make sure that the unit and power connection have good earthing, otherwise may cause electrical shock.
4. If the supply cord is damaged, it must be replaced by the manufacturer or our service agent or similarly qualified person in order to avoid a hazard.
5. Directive 2002/96/EC (WEEE):
The symbol depicting a crossed-out waste bin that is underneath the appliance indicates that this product, at the end of its useful life, must be handled separately from domestic waste, must be taken to a recycling centre for electric and electronic devices or handed back to the dealer when purchasing an equivalent appliance.
6. Directive 2002/95/EC (RoHs): This product is compliant with directive 2002/95/EC (RoHs) concerning restrictions for the use of harmful substances in electric and electronic devices.
7. The unit CANNOT be installed near the flammable gas. Once there is any leakage of the gas , fire can be occur.
8. Make sure that there is circuit breaker for the unit, lack of circuit breaker can lead to electrical shock or fire.
9. The heat pump located inside the unit is equipped with an over-load protection system. It does not allow for the unit to start for at least 3 minutes from a previous stoppage.
10. The unit can only be repaired by the qualified personnel of an installer center or an authorized dealer. (for North America market)
11. Installation must be performed in accordance with the NEC/CEC by authorized person only. (for North America market)
12. USE SUPPLY WIRES SUITABLE FOR 75°C.
13. Caution: Single wall heat exchanger, not suitable for potable water connection.

Appendix

6. Appendix 2、Cable specification

1. Single phase unit

Nameplate maximum current	Phase line	Earth line	MCB	Creepage protector	Signal line
No more than 10A	$2 \times 1.5\text{mm}^2$	1.5mm^2	20A	30mA less than 0.1 sec	$n \times 0.5\text{mm}^2$
10~16A	$2 \times 2.5\text{mm}^2$	2.5mm^2	32A	30mA less than 0.1 sec	
16~25A	$2 \times 4\text{mm}^2$	4mm^2	40A	30mA less than 0.1 sec	
25~32A	$2 \times 6\text{mm}^2$	6mm^2	40A	30mA less than 0.1 sec	
32~40A	$2 \times 10\text{mm}^2$	10mm^2	63A	30mA less than 0.1 sec	
40~63A	$2 \times 16\text{mm}^2$	16mm^2	80A	30mA less than 0.1 sec	
63~75A	$2 \times 25\text{mm}^2$	25mm^2	100A	30mA less than 0.1 sec	
75~101A	$2 \times 25\text{mm}^2$	25mm^2	125A	30mA less than 0.1 sec	
101~123A	$2 \times 35\text{mm}^2$	35mm^2	160A	30mA less than 0.1 sec	
123~148A	$2 \times 50\text{mm}^2$	50mm^2	225A	30mA less than 0.1 sec	
148~186A	$2 \times 70\text{mm}^2$	70mm^2	250A	30mA less than 0.1 sec	
186~224A	$2 \times 95\text{mm}^2$	95mm^2	280A	30mA less than 0.1 sec	

2. Three phase unit

Nameplate maximum current	Phase line	Earth line	MCB	Creepage protector	Signal line
No more than 10A	$3 \times 1.5\text{mm}^2$	1.5mm^2	20A	30mA less than 0.1 sec	$n \times 0.5\text{mm}^2$
10~16A	$3 \times 2.5\text{mm}^2$	2.5mm^2	32A	30mA less than 0.1 sec	
16~25A	$3 \times 4\text{mm}^2$	4mm^2	40A	30mA less than 0.1 sec	
25~32A	$3 \times 6\text{mm}^2$	6mm^2	40A	30mA less than 0.1 sec	
32~40A	$3 \times 10\text{mm}^2$	10mm^2	63A	30mA less than 0.1 sec	
40~63A	$3 \times 16\text{mm}^2$	16mm^2	80A	30mA less than 0.1 sec	
63~75A	$3 \times 25\text{mm}^2$	25mm^2	100A	30mA less than 0.1 sec	
75~101A	$3 \times 25\text{mm}^2$	25mm^2	125A	30mA less than 0.1 sec	
101~123A	$3 \times 35\text{mm}^2$	35mm^2	160A	30mA less than 0.1 sec	
123~148A	$3 \times 50\text{mm}^2$	50mm^2	225A	30mA less than 0.1 sec	
148~186A	$3 \times 70\text{mm}^2$	70mm^2	250A	30mA less than 0.1 sec	
186~224A	$3 \times 95\text{mm}^2$	95mm^2	280A	30mA less than 0.1 sec	

When the unit will be installed at outdoor, please use the cable which can against UV.



WATERWARE

Proud members of



waterware.co.nz
info@waterware.co.nz
+64 9 273 9191

